

Operating manual

Intelligent pump controller

bplogic



Please read this manual prior to starting any work!

Brinkmann Pumpen
K.H. Brinkmann GmbH & Co. KG
Friedrichstr. 2
58791 Werdohl
GERMANY
+49 2392 5006-0
sales@brinkmannpumps.de
www.brinkmannpumps.de

BRIN-46069-EN, Version 03.03, en_UK

© Brinkmann Pumpen 2022

Table of contents

1 Overview.....	7
1.1 Preliminary remarks.....	7
1.2 General description of the intelligent pump controller	9
1.3 Pump tasks and system integration.....	10
2 Safety.....	12
2.1 Symbols in this operating manual.....	12
2.2 Proper use.....	14
2.3 Safety equipment.....	15
2.4 Residual risks	16
2.5 Owner responsibility	19
2.6 Staff requirements	21
2.7 Personal protective equipment	23
2.8 Environmental protection.....	24
3 Pump controller fields of application.....	25
3.1 Typical areas of application	25
3.2 Pump controller layout.....	26
3.2.1 Housing.....	27
3.2.2 Touchscreen	28
3.2.3 I/O level slots.....	29
3.2.4 I/O modules and slot allocation	30
3.2.5 USB and micro SD.....	33
3.2.6 Ethernet.....	34
3.2.7 Modbus RTU.....	35
3.2.8 Supported bus protocols	35
3.2.9 Connections and interfaces.....	36
3.2.10 Automatic and manual mode.....	38
4 Installing the pump controller	39
4.1 Fitting the pump controller	39

4.2	Network topologies	41
4.3	Connecting the pump controller electrically	42
4.3.1	Basic layout of the I/O level	42
4.3.2	Connecting I/O modules	43
5	Operating the pump controller	52
5.1	Switching on and logging in	52
5.1.1	Optional pump controller operation via remote access.....	54
5.2	Operating principles	56
5.2.1	General screen layout	56
5.2.2	Status bar	58
5.2.3	Title bar	59
5.2.4	Navigation bar	59
5.2.5	Main screen.....	62
5.2.6	Dialogue: "Quick access".....	68
5.2.7	Navigation	70
5.2.8	Input helps.....	73
5.2.9	Global data	79
5.2.10	File manager	81
5.2.11	Main menu overview.....	83
5.3	Application modules.....	91
5.3.1	Checking the assignments to application modules	92
5.3.2	Displaying parameters as favourites.....	97
5.3.3	Switching the application module into manual mode	99
5.4	Primary functions	100
5.4.1	Executing adjustment mode with one pump	100
5.4.2	Executing control mode with one pump.....	103
5.4.3	Parallel mode	105
5.4.4	Saw tooth cycle mode	109
5.4.5	Pressure increase.....	115
5.4.6	Logic module	117
5.5	Secondary functions	158
5.5.1	Offset control	158

5.5.2	Wear detection	159
5.6	Setting pump controller parameters.....	166
5.6.1	Setting I/O parameters	168
5.6.2	System settings.....	190
5.6.3	Setting LAN parameters.....	202
5.6.4	Setting WLAN module parameters.....	205
5.6.5	Checking field bus parameters.....	208
5.6.6	Using the PROFINET IO field bus or the EtherNet/IP field bus	211
5.6.7	Exchanging data	219
5.7	Operation.....	224
5.7.1	Locking and unlocking the screen	224
5.7.2	Ejecting the removable storage device safely	225
5.7.3	Using the application overview during operation	227
5.7.4	Using the pump overview during operation	229
5.7.5	Using the application oscilloscope during operation.....	232
5.8	Shutting down the pump controller	238
5.9	Re-commissioning after an extended shutdown	238
6	Additional functions.....	239
6.1	Using logging.....	240
6.2	WLAN	244
6.3	Automatic time setting	246
7	Performing maintenance.....	248
7.1	Cleaning the housing.....	248
7.2	Backup and restore	249
7.2.1	Backup and restore preparation	250
7.2.2	Backing up and updating application modules	251
7.2.3	Backing up and updating the system software	254
7.2.4	Backing up and updating settings	257
7.3	Event messages	260
7.3.1	Layout of an event message	260

7.3.2	Acknowledging and closing event messages	261
7.3.3	“Event list” menu	263
7.4	Fault table	267
7.5	Restarting in the event of errors	268
8	Technical data	269
8.1	Device properties	269
8.1.1	Functions	270
8.1.2	Frequency converter	270
8.1.3	Interfaces	270
8.1.4	WLAN communication	271
8.2	Ambient and operating conditions	272
8.3	Electrical properties	273
8.3.1	Pump controller	273
8.3.2	I/O module 1	274
8.3.3	I/O module 2	276
8.4	Connection line requirements	278
8.5	Permits	278
8.6	Type plate	279
8.7	Supplied as standard	279
9	Storage, transport, dismantling and disposal	280
9.1	Storage and transport	280
9.2	Dismantling and disposal	280
10	Licensing information	282
11	EC Declaration of Conformity	283
12	Accessories and required materials	285
13	Index	286

1 Overview

1.1 Preliminary remarks

Information regarding this operating manual

This operating manual (subsequently referred to as “Manual”) contains important information that must be observed when installing, operating and maintaining the blogic intelligent pump controller (subsequently referred to as “pump controller”). This operating manual must therefore be read by the electricians and the responsible technical personnel/owner prior to assembly and commissioning and must always be available at the pump controller’s operating location.

Illustrations in this operating manual are for basic understanding and may differ from the actual design.

Complete installation

The pump controller is part of a system to supply machine tools with cooling lubricant. “Complete installation” or “system” designates all of the installations, machines, sensors, and actuators controlled by the pump controller, as well as their safety equipment.



The pump controller and the complete installation are considered a functional unit here even if the complete installation is not supplied as standard.

Further applicable documents

In addition to this operating manual, also observe the documentation for all machines and other installations contained in the complete installation, as well as the documents relevant for assembly and safety:

- Documentation for:
 - Machines (e.g. pumps)
 - Frequency converters
 - Actuators (e.g. valves)
 - Sensors (e.g. throughput, pressure sensors)
 - Safety equipment
 - Other installations

- Higher-level controllers (e.g. machine tool)
- Configurator (requirements on the pump controller's manufacturer-side configuration before installation)
- The parameter list for the pump controller.
- Operating instructions of the operator.



The order and delivery notes, as well as the system-specific configurator, provide an overview of the complete installation.

Customer service



When contacting customer service:

- Provide customer service with the current configuration file
↳ *Section 7.2.1 "Backup and restore preparation" on page 250.*
And/or:
- Have the pump controller's order number and serial number at hand.

Address	Brinkmann Pumpen K.H. Brinkmann GmbH & Co. KG Friedrichstr. 2 58791 Werdohl GERMANY
Phone	+49 2392 5006-0
E-mail	sales@brinkmannpumps.de
Internet	www.brinkmannpumps.de

1.2 General description of the intelligent pump controller

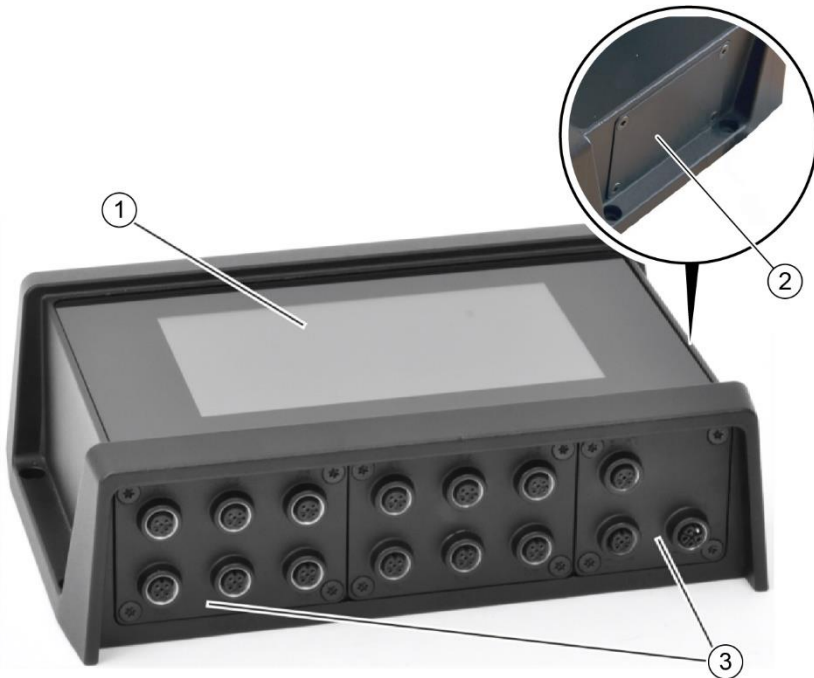

Fig. 1: Overview (sample illustration)

- 1 Touchscreen
- 2 Service access
- 3 I/O level

The pump controller (Fig. 1) consists of a cast aluminium housing, inside of which the main circuit board is located.

The touchscreen (Fig. 1/1) and the I/O level with the connections (Fig. 1/3) are accessible for the operator from the outside. Various I/O modules can be inserted into the I/O level and therefore connected to the main circuit board. The service access (Fig. 1/2) is located on one of the two short device sides.

The service access is sealed with a cover during operation. After opening the screws, two USB connections, one RJ45 Ethernet connection for service purposes and one Micro SD slot are accessible.

1.3 Pump tasks and system integration

Pump tasks

The pump controller co-ordinates pump tasks, e.g. supplying machine tools with cooling lubricant. The pump controller controls the pumps contained in the complete installation, bearing in mind the sensors and actuators that can be connected to the pump controller. Up to 6 pumps can be connected. The pumps can be operated individually or together, e.g. to also achieve even balanced utilisation.

The sensors, pumps and remaining actuators can be combined in up to 6 application modules. In this context, “application modules” means basic application functions (adjustment, control, pressure increase and rinsing applications). The number, type and scope of the application modules depend on the complete installation’s task and equipment.

System integration

The pump controller controls the pumps contained in the complete installation (generally via frequency converters) depending on the selected application module and the sensor signals present (e.g. flow rate or pressure).

Information is exchanged between the complete installation (sensors and actuators) and the higher-level controller using different field bus protocols (ethernet or modbus connection) or in the form of analog and digital signals. A PROFINET IO field bus can be used additionally on a pump controller with the PROFINET option.

The pump controller is delivered preconfigured for the complete installation into which it is integrated. After assembly, you only have to set parameters for functions and settings.

Supported frequency converters

- ABB
- Brinkmann
- Danfoss
- Emotron
- Fuji Electric
- Kostal
- Mitsubishi

2 Safety

2.1 Symbols in this operating manual

Safety instructions

Safety instructions in this manual are marked by symbols. The safety instructions are introduced by signal words that express the degree of danger.



DANGER!

This combination of symbol and signal word advises of an immediately dangerous situation that causes death or serious injuries if not avoided.



WARNING!

This combination of symbol and signal word advises of a possibly dangerous situation that may cause death or serious injuries if not avoided.



CAUTION!

This combination of symbol and signal word advises of a possibly dangerous situation that may cause moderate or minor injuries if not avoided.



NOTICE!

This combination of symbol and signal word advises of a possibly dangerous situation that may cause damage to property if not avoided.



ENVIRONMENTAL PROTECTION!

This combination of symbol and signal word advises of possible dangers for the environment.

Tips and recommendations



This symbol highlights useful tips and recommendations, and information for efficient and fault-free operation.

Other labels

The following labels are used in this manual to highlight handling instructions, results, lists, references and other elements:

Label	Explanation
1., 2., 3. ...	Step-by-step handling instructions
⇒	Results of handling instructions
↔	References to other sections in this manual and to further applicable documents
•	Lists without a fixed order
<i>[Button]</i>	Controls (e.g. buttons, switches), indicators (e.g. indicator lights)
<i>“Display”</i>	Screen elements (e.g. on-screen buttons, allocation of function keys)

Safety instructions in handling instructions

Safety instructions can refer to specific, individual handling instructions. These safety instructions are embedded into the handling instruction so that they do

not interrupt the flow of text when performing the handling instruction. The aforementioned signal words are used.

Example:

1. Undo the screw.



CAUTION!

Risk of pinching on the cover!

2. Close the cover carefully.
3. Screw the screw tight.

2.2 Proper use

The pump controller co-ordinates pump tasks, e.g. supplying machine tools with cooling lubricant.

The pump controller is intended solely to operate a complete installation as described in the configurator and in this operating manual.

Proper use also includes adhering to all specifications in this operating manual. Any use that differs from or goes beyond proper use is considered misuse.

**WARNING!****Danger if misused!**

Misusing the intelligent pump controller can cause dangerous situations.

- Never grant unauthorised people access to the pump controller.
- Never set target values that are outside the controlled machine's specifications.
- Never set target values that are outside the application-specific operating conditions.
- Never operate the pump controller without additional system-specific safety equipment.
↳ *Observe Section 2.3 "Safety equipment" on page 15.*
- Never use the pump controller to switch the controlled machine off for maintenance or troubleshooting purposes.
- Never operate the pump controller in an explosive atmosphere.
- Never open the pump controller's housing.
- Never convey media that is not specified for the pumps, actuators, sensors and installations into the complete installation.

2.3 Safety equipment



The pump controller is not a piece of safety equipment. The system owner is responsible for developing a system-wide safety concept and equipping the system with corresponding safety equipment.

Each system component can pose hazards. The system owner is responsible for checking whether using the pump controller would make further safety equipment necessary, such as using a safety control system.

Retrofitting safety functions



DANGER!

Danger of serious to fatal injuries due to operating the complete installation unsafely!

Ensure that safety equipment is installed for the complete installation's specific dangers (e.g. to prevent overpressure, uncontrolled start-ups and to create a safe state).

2.4 Residual risks

Safe state of the complete installation



DANGER!

Danger of serious to fatal injuries due to an unsafe complete installation!

The pump controller does not have any safety functions.

Operating errors or faults can cause faults in the complete installation (e.g. overpressure, uncontrolled start-ups), which can result in serious injuries or material damage.

- Do not operate the pump controller in a complete installation if none of the safety equipment specified for the complete installation's concrete hazards is installed and ready for operation.
- For more information, see the further applicable documents (↪ "Further applicable documents" on page 7), especially:
 - Documentation for the machines, actuators, sensors and safety equipment in the complete installation.
 - Owner operating instructions.

Power supply requirements



DANGER!

Danger of electric shock due to improper power supply!

The pump controller requires SELV (safety extra-low voltage) / PELV (protective extra-low voltage) power with high insulation requirements to be used. If these requirements are not met, there is the risk of serious to fatal injuries due to electric shock.

- Ensure that the 24 V power supply meets the requirements of protective extra-low voltage (PELV) or safety extra-low voltage (SELV protection class III).
- The electrical connection may only be established by an electrician.

Consideration of the maximum permissible currents



DANGER!

Danger of serious to fatal injuries due to missing or incorrectly designed overcurrent protective devices!

The maximum supply currents for the “Logic and sensors” and the “Actuators” voltage domains must be limited. In the event of short circuits or impermissibly high currents, impermissibly high maximum currents may overload the pump controller and/or lines. For this reason, the owner must ensure that the specified maximum currents are not exceeded and also that external overcurrent protection units and connection lines with the correct measurements are used in order to prevent an overload condition. Otherwise, there is a risk of serious to fatal injury due to fire.

- When connecting sensors and especially actuators, observe the maximum permissible currents per connection and in total:
 - ↪ *Section 8.3 “Electrical properties” on page 273*
 - ↪ *Section 8.3.2 “I/O module 1” on page 274*
 - ↪ *Section 8.3.3 “I/O module 2” on page 276*
- The electrical connection may only be established by an electrician.

Housing protection category



NOTICE!

Risk of damage due to penetrating moisture!

The pump controller is protected against moisture by the design of the housing and connections in accordance with IP65. If the housing is opened without authorisation or the connections are not established properly, protection category IP20 applies to the housing. In this case, penetrating moisture can cause malfunctions or damage to the pump controller.

- Screw the M12 connections for slots A - C together properly.
- Cover unwanted M12 connections with sealing caps (supplied as standard).
- Always close the service access cover properly.
- Do not open any of the other screw connections on the housing.

Loss of warranty



NOTICE!

Do not open the housing!

There are no components relevant for operation, maintenance or troubleshooting in the housing. The housing may only be opened by the manufacturer's staff.

2.5 Owner responsibility

Owner

The owner is the person who operates the pump controller and the complete installation for commercial or economic purposes themselves or contracts a third party to use/operate it, and who bears the legal product responsibility for protecting the user, the staff or third parties during operation.

Owner obligations

The pump controller and the complete installation are used in industrial applications. The owner is therefore obliged to comply with and implement the legal obligations for occupational safety.

In addition to the safety instructions in this operating manual, the safety, occupational safety and environmental protection regulations that are applicable for the pump controller's application area must be adhered to at all times.

The following applies in particular:

- The owner must inform himself of the applicable occupational safety regulations and use a risk assessment to determine additional hazards that are posed by the special working conditions at the operating location for the pump controller and the complete installation. Occupational safety must be ensured by additional operating instructions for operating the pump controller and the complete installation.
- The owner must retrofit safety equipment to protect against dangers that arise due to operating the complete installation.
- For the entire usage duration of the pump controller and the complete installation, the owner must check whether the operating instructions that they drew up correspond to the current rules and standards, and adjust the operating instructions if required.
- The owner must clearly define responsibilities for installation, operation, troubleshooting, maintenance and cleaning.
- The owner must ensure that everybody who handles the pump controller and the complete installation has read and understood this operating manual. Furthermore, they must train the staff in regular intervals and inform them of the dangers.
- The owner must provide the staff with the required protective equipment and instruct that wearing it is mandatory.

Furthermore, the owner is responsible for ensuring that the pump controller and the complete installation are always in a technically perfect condition. Therefore, the following applies:

- The owner must ensure that the maintenance intervals described in this operating manual and the further applicable documents are adhered to.
- The owner must have all safety equipment checked on a regular basis to ensure that it is functioning and complete.

2.6 Staff requirements



WARNING!

Risk of injury if staff are insufficiently qualified!

If unqualified staff work on the pump controller, hazards that can cause serious injuries and significant damage to property occur.

- Only allow qualified staff to perform any work.
- Keep unqualified staff away from danger zones.

Qualifications

This operating manual specifies the following staff qualifications for the various work areas:

Pump controller operator

The pump controller operator is familiar with the complete installation. The pump controller operator knows the dangers posed by the complete installation and can assess the consequences of their operating steps.

The owner ensures that the pump controller operator has the required qualifications and the required training.

Electrician

The electrician is able to perform work on electrical systems and to identify and avoid possible dangers independently due to their technical training, knowledge, experience and knowledge of the applicable standards and regulations.

The owner ensures that only staff with the required qualifications and the required training perform work on the complete installation.

Manufacturer's assembly staff

The manufacturer's assembly staff are able to assemble and commission the pump controller and the complete installation and to identify and avoid possible dangers independently due to their technical training, knowledge, experience and knowledge of the applicable standards and regulations.

Only people who can be expected to perform their work reliably are permitted to be employed as staff. People with impaired reactions, e.g. due to drugs, alcohol or medication, are not permitted.

Observe the age and job specific regulations valid at the operating location when selecting the staff.

User level

- Manufacturer (Brinkmann)
- Service (customer)
- Operator (customer)
- User (customer)

Instruction

The commercial owner must instruct the staff on a regular basis. A training log with at least the following content must be created for better tracking:

- Date of training
- Name of trainee
- Contents of training
- Name of trainer
- Signature of trainee and trainer

2.7 Personal protective equipment



No personal protective equipment is required for setting parameters, operation and maintenance and troubleshooting work on the pump controller performed via the touchscreen.

Depending on the installation location and the complete installations, personal protective equipment may be required, and this is expressed in further documents as follows:

- Observe the documentation for the machines that are installed.
- Observe the operating instructions.

Also see: ↗ “Further applicable documents” on page 7



CAUTION!

Ensure that the pump controller does not fall from great heights and injure you when unpacking, assembling and dismantling. Pay attention to the latest state of technology, as well as the current accident prevention regulations.

At least the following personal protective equipment is required to assemble and dismantle the pump controller:



Safety shoes

Safety shoes protect the feet against crushing, falling parts and slipping on slippery surfaces.

There may be other requirements depending on the installation location and the complete installation, such as wearing a hard hat.

2.8 Environmental protection



ENVIRONMENTAL PROTECTION!

Environmental hazard due to handling substances that are harmful to the environment incorrectly!

Handling substances that are harmful to the environment incorrectly, especially disposing of them incorrectly, can cause significant environmental damage.

- Always observe the instructions below regarding handling and disposing of substances that are harmful to the environment.
- If substances that are harmful to the environment are released into the environment inadvertently, take immediate measures. If in doubt, inform the local authority responsible of the damage and enquire about suitable measures to be taken.

The following substances that are harmful to the environment are used:

Electronic components

Electronic components can contain substances or assemblies that are harmful to the environment and that can be recycled. Collect electronic components separately and only have them recycled or disposed of by licensed specialist disposal companies.

Packaging materials

Packaging materials are valuable raw materials and can often be re-used or processed sensibly and recycled. If you plan to transport or store the pump controller, it makes sense to keep the original packaging.

- Have packaging materials that are no longer required recycled or disposed of in an environmentally friendly manner.
- Observe the locally applicable disposal regulations. If in doubt, commission a specialist company with disposal.

3 Pump controller fields of application and layout

3.1 Typical areas of application

A typical application is supplying machine tools with cooling lubricant and disposing of it.

The machine tool transfers requirements (e.g. regarding pressure or flow rate) according to its operating condition. The controller controls based on these specifications and its configuration, as well as the parameters set for the pumps and actuators that are connected, in order to operate the pumps at the optimum operating point for instance.

The pump controller can control up to 6 pumps and the sensors and actuators such as valves or shut-off valves connected to form a functional unit (“complete installation”). The pumps can be used individually or as a group. Different applications can be assigned to the pumps, of which there are up to 6 different possibilities.

The typical tasks include:

- supplying machine tools and machining centres with cooling lubricant
- pumping filtered cooling lubricant or cooling lubricant that contains chips
- filtering the cooling lubricant return line from the machine tool or the machining centre

The processes required for this are stored as application modules in the pump controller.

- Maximum of 6 application modules (more upon request)
- Application modules:
 - Adjustment mode
 - Control mode
 - Parallel mode
 - Pressure increase
 - Saw tooth cycle mode
 - Logic module
- Maximum of 6 frequency converters (more upon request)

3.2 Pump controller layout

Pump controller overview

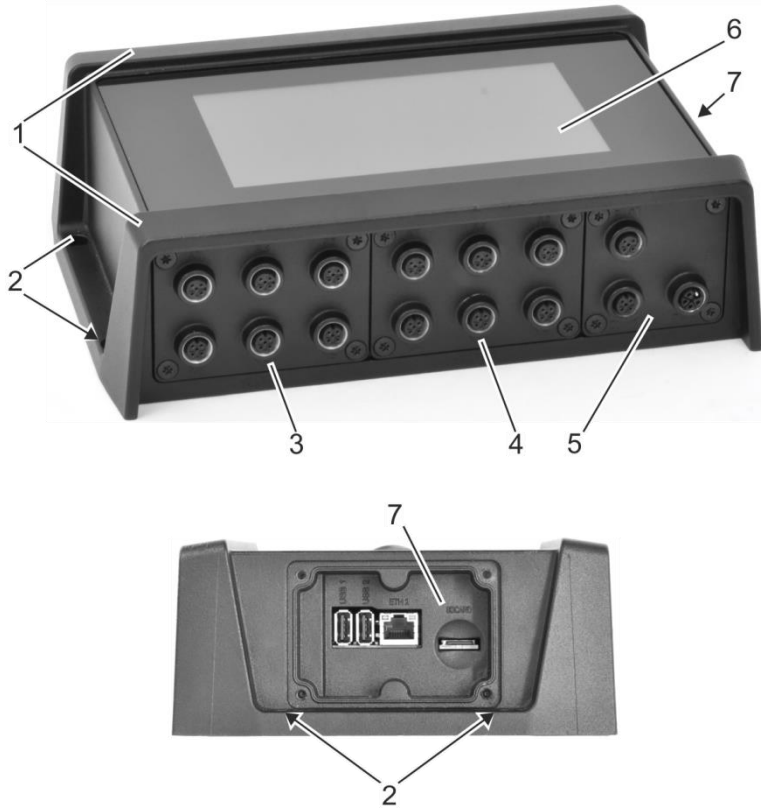

Fig. 2: Overview (sample configuration)

- | | | | |
|---|----------------------------|---|-----------------------|
| 1 | Housing | 5 | I/O level/slot C |
| 2 | Holes for fastening screws | 6 | Touchscreen |
| 3 | I/O level/slot A | 7 | Service access (open) |
| 4 | I/O level/slot B | | |

3.2.1 Housing



Fig. 3: Housing (sample configuration)

- 1 Housing
- 2 Touchscreen
- 3 Service access
- 4 I/O level/slots A - C

The housing (Fig. 3/1) is made of die-cast aluminium. The touchscreen (Fig. 3/2) is built into the top.

The base and the 3 elements on the I/O level (slots A, B and C, Fig. 3/4) are designed as individual die-cast aluminium elements that are screwed to the remainder of the housing. Only the manufacturer's service staff are permitted to open it. Opening the housing without authorisation voids the manufacturer's warranty. The service access (Fig. 3/3) is part of the die-cast housing.

All housing openings are sealed. Sealing caps are supplied to cover any unused M12 connections. Any unused slots on the I/O level are sealed with a blanking plate. When protected in such a fashion the housing has protection category IP65.

3.2.2 Touchscreen



Fig. 4: Touchscreen

The pump controller's only control is a touch-sensitive 7"-colour display (capacitive touch function, Fig. 4/1).

The pump controller can be operated vertically and horizontally. The display and touchscreen orientation can be adjusted to the installation position manually in 90° increments.



CAUTION!

Avoid touching a faulty or cracked display glass. There is a risk of cutting injuries. Stop using a device with a faulty display immediately, as it may also no longer be able to comply with the required protection class.

Operating system and application modules

The operating system and the application modules are pre-installed when delivered. The operating system can be stored on the pump controller's internal flash memory or on external storage media.

The boot sequence is as follows:

1. external USB storage medium
2. external micro SD card
3. internal eMMC memory

3.2.3 I/O level slots

The I/O level designates the connections on the long side of the housing (Fig. 5). The I/O level comprises 3 divided modules (Fig. 5/1 - 3) that can be inserted and screwed into slots A - C.

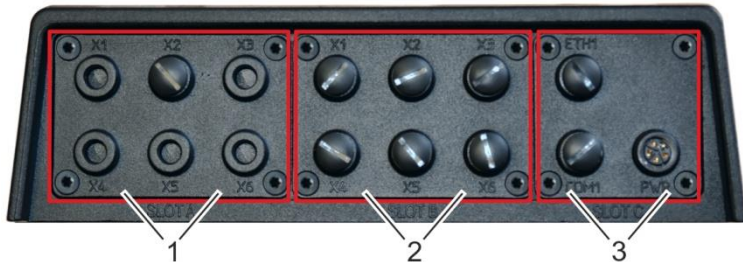

Fig. 5: I/O level slots

- 1 Slot A: ↪ [Section 3.2.4.1 "Slot A" on page 30](#)
- 2 Slot B: ↪ [Section 3.2.4.2 "Slot B" on page 31](#)
- 3 Slot C: ↪ [Section 3.2.4.3 "Slot C" on page 32](#)

The modules are screwed to the housing and connected to the main board on the inside.

Slots A and B are the same size and have the same connection fields inside the device. Therefore, the same types of I/O modules can be inserted into slots A and B, e.g. two I/O modules 2. If only one slot is filled, the second must be sealed with a cover plate.



CAUTION!

Pay attention to the pointed pin bars when installing/removing I/O modules. Grip the I/O modules by the outer edge if possible and insert the I/O modules into the intended slots carefully. Ensure that you do not injure yourself on the pointed pin bars.

I/O modules may only be inserted into/removed from the pump controller by an electrician.

3.2.4 I/O modules and slot allocation

3.2.4.1 Slot A

I/O module 1

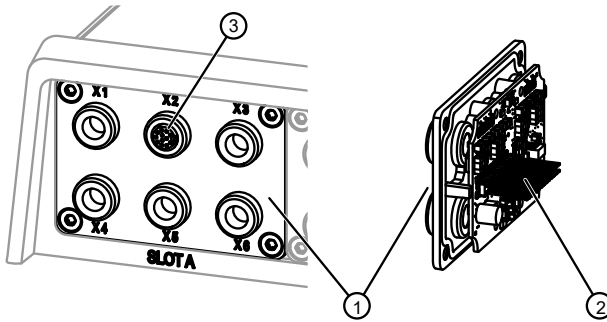

I/O module 1 in slot A with sealing cap-01.svg

Fig. 6: I/O module 1 in slot A (with sealing cap)

- 1 Housing outside/connections X1 – X6
- 2 Housing inside/contacts to main board
- 3 12-pin M12 connection to X2

I/O module 1 (Fig. 6) is inserted into slot A.

On a 12-pin M12 connection (here in X2, Fig. 6/3), I/O module 1 provides 5 digital inputs, 4 switchable digital inputs/outputs and one analog input and output each.

In order to maintain the IP65 level of protection, the unused M12 connections must be sealed with the sealing caps provided.

3.2.4.2 Slot B

I/O module 2

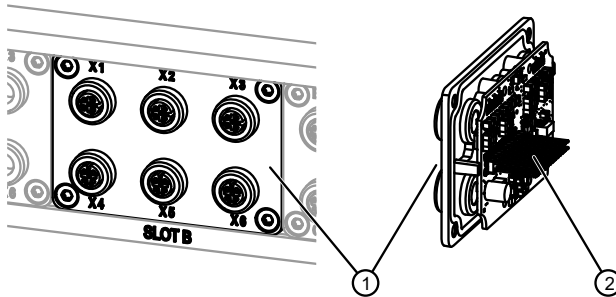

Fig_Slot B.svg

Fig. 7: Slot B

- 1 Housing outside/connections X1 – X6
- 2 Housing inside/contacts to main board

One I/O module 2 (☞ *Section 8.3.3 “I/O module 2” on page 276*) can be inserted into both slot A and slot B.

On 6 M12 connections (X1 to X6), one I/O module 2 provides 2 digital and analog inputs, 4 digital outputs and one analog output.

In order to maintain the IP65 level of protection, the unused M12 connections must be sealed with the sealing caps provided.

3.2.4.3 Slot C

Power module

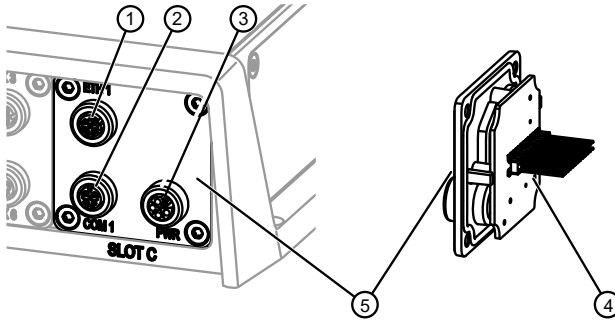

Fig_Slot C.sng

Fig. 8: Slot C

- 1 ETH 1: Ethernet or ethernet-based field bus
- 2 COM 1: Modbus RTU
- 3 PWR: 24 V power supply
- 4 Housing inside/contacts to main board
- 5 Housing outside/connections

The module in slot C contains the power supply connection (24 V DC, Fig. 8/3), the ETH 1 ethernet connection (Fig. 8/1) and the modbus RTU connection (COM 1, Fig. 8/2). Each of the connections is designed as an M12 socket.

The ETH 1 ethernet connection is intended to connect the pump controller permanently to an ethernet network or a field bus.

The M12 socket can be used to establish the connection while retaining housing protection category IP65. In order to obtain the housing protection category, the unused M12 connections must be sealed with the sealing caps provided.

The power supply (24 V DC) is established via the PWR connection (M12 connection, Fig. 8/3) and feeds sensors and the main board galvanically separated from the actuators, so that any overcurrent in the actuators does not cause the logic and sensors to fail. If actuators with a high current requirement are to be supplied, this can be performed by a second 24 V power supply.



Also see:

- [Section 3.2.6 “Ethernet” on page 34](#)
- [Section 3.2.7 “Modbus” on page 35](#)
- [Section 3.2.9.2 “Power supply for actuators, sensors and logic” on page 36](#)

3.2.5 USB and micro SD

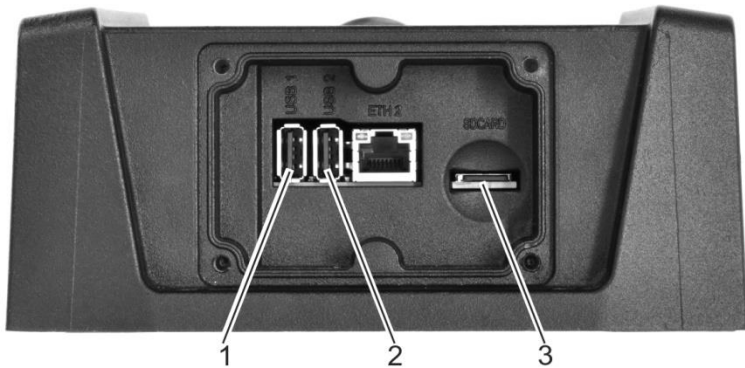

Fig. 9: USB connections, micro SD slot

Further USB media can be connected to the USB connections on the service access (Fig. 9/1 + 2) in order to increase the memory capacity.

Furthermore, an optional USB WLAN stick can be plugged in to the USB connections. In order to avoid impairing the radio connection, the die-cast aluminium cover on the service access must be replaced with a plastic cover.

USB dongles may only protrude by a maximum of 1.5 cm when plugged in so that the cover on the service access can be closed.

A micro SD card (up to 32 GB capacity, Fig. 9/3) can also be inserted to increase the memory.

3.2.6 Ethernet



NOTICE!

The pump controller's ETHERNET interfaces are only intended for connection to computer networks (LANs) and are not permitted to be connected to telephone networks or telecommunication circuits.

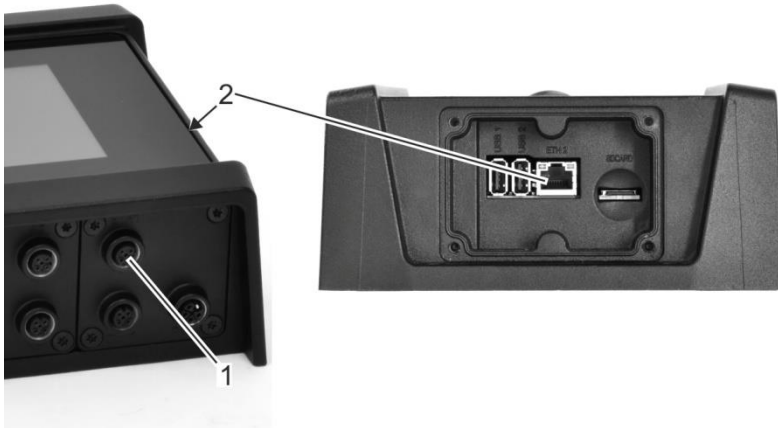

Fig. 10: Ethernet connections

The pump controller has 2 ethernet connections:

- ETH 1 in slot C (LAN 1, Fig. 10/1, M12 connection)
- ETH 2 in the service access (LAN 2, Fig. 10/2, RJ45 connection)

The ETH -1 interface in slot C is intended for a permanent connection to an ethernet or an ethernet-based field bus system. The M12 socket enables the connection while retaining the housing protection category.

The ETH-2 interface in the service access is used for temporary access for service and maintenance purposes. As the cover on the service access has to be opened in order to use this feature, housing protection level IP65 is sacrificed by this until the service access is closed again properly.

The ETH 1 and ETH 2 ethernet interfaces are not switched.

3.2.7 Modbus RTU



Fig. 11: Modbus RTU connection

The modbus RTU connection is established via slot C (M12 connection, Fig. 11/1) on the I/O level. Communication with the pumps is performed via modbus RTU.

3.2.8 Supported bus protocols

The pump controller supports the following bus protocols:

- Field bus, each with M12 connection (A-coded):
 - Modbus RTU
 - CAN and CANopen upon request
- Real-time ethernet, each with M12 connection (D-coded):
 - PROFINET RT
 - EtherNet/IP
 - other field buses upon request

3.2.9 Connections and interfaces

The power is supplied to the pump controller and connections (except for ETH 2 ethernet and WLAN) are established via the I/O level ↪ *Section 3.2.4 “I/O modules and slot allocation” on page 30*. The pump controller has two separate circuits for internal power supply:

- ↪ *Section 3.2.9.2 “Power supply for actuators, sensors and logic” on page 36*

3.2.9.1 Pump controller power supply

The pump controller requires 24 V DC. This is supplied by the power module. Design the 24 V power supply as protective extra-low voltage (PELV) or safety extra-low voltage (SELV protection class III).

3.2.9.2 Power supply for actuators, sensors and logic

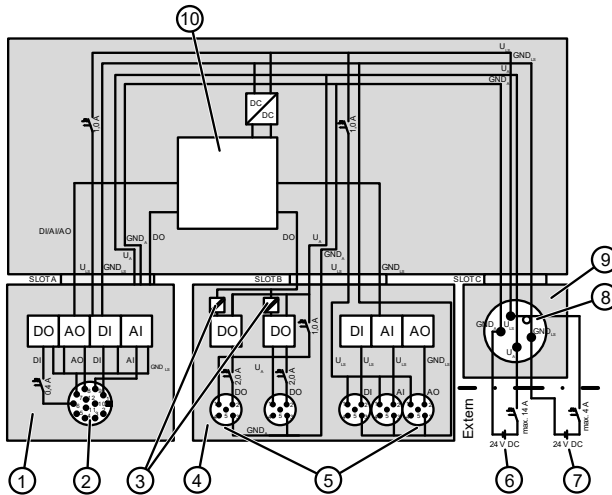

Fig. 12: Connection diagram for sensors and actuators

Fig_Block_diagram_BPlogic.svg

1	I/O module 1	6	Actuator supply
2	Sensor/actuator connection	7	Logic and sensor supply
3	Galvanic separation level	8	Power supply connection
4	I/O module 2	9	Power module
5	Sensor/actuator connection	10	Electronics

The power supply for the actuators (Fig. 12/6) is separated from the power supply for the sensors and the logic (Fig. 12/7) by a galvanic separation level (Fig. 12/3). The actuators can therefore be supplied by a separate power supply without impairing the logic or sensors if the required power is higher.

- ▶ Ensure that the maximum permissible supply currents for the pump controller and the I/O modules installed on the pump controller are not exceeded.

Fuses that conform with UL must be used to safeguard the sensor power supply.

- ▶ To safeguard the sensor power supply, use fuses that conform with UL for a maximum rated current of 4 A with a characteristic that trips in less than 120 seconds in the event of an overcurrent of 6.4 A.

There are no special specifications for selecting the fuses to safeguard the actuator power supply. The following applies to the actuator power supply:

- ▶ Ensure that the maximum permissible rated current of 14 A is not exceeded.



For the connection values, see:

- ↪ *Section 8.3 “Electrical properties” on page 273*
- ↪ *Section 8.3.2 “I/O module 1” on page 274*
- ↪ *Section 8.3.3 “I/O module 2” on page 276*

3.2.10 Automatic and manual mode

3.2.10.1 Automatic mode

In automatic mode, the pump controller is remote controlled by a higher-level controller (e.g. a machine tool). To do this, the pump controller reports that it is ready for operation to the higher-level controller (e.g. a machine tool): Furthermore, the machine tool requests the required application modules and supplies them with the required target values or other information.

The pump controller evaluates this information and controls the application modules and pumps automatically in order to perform the provision of the medium required by the higher-level controller.

3.2.10.2 Manual mode

Manual mode enables the operating staff to perform individual operation processes on the touchscreen.

- ▶ Only use manual mode to try out settings for the parameters and to perform test runs of individual components.
 - ⇒ As long as manual mode is activated for individual or several pumps or applications, the higher-level controller does not receive a notification that it is ready for operation.

Standard mode



Use automatic mode!

Automatic mode is the pump controller's standard mode.

Only use manual mode for installation, commissioning or troubleshooting.

4 Installing the pump controller

4.1 Fitting the pump controller

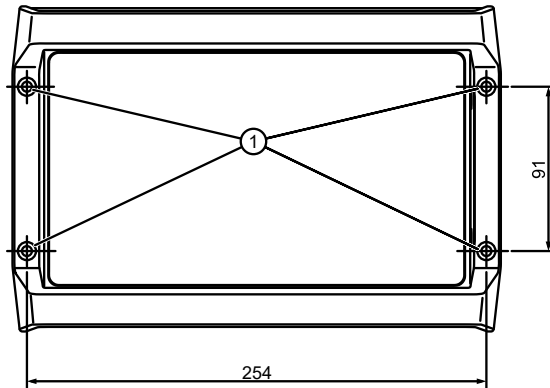

Fig. 13: Horizontal installation

1 Holes for fastening screws

Staff:

- Manufacturer's assembly staff

- Electrician

Protective equipment:

- Safety shoes

1. Selecting the setup location:

- Install the pump controller indoors.
- Adhere to the ambient conditions (☞ *Section 8.2 "Ambient and operating conditions" on page 272*), particularly the permissible temperatures for operating the pump controller (-20 °C – 55 °C).
- Do not expose the pump controller to direct sunlight.
- If there is a risk of overheating, ensure that fresh air supply/ventilation is available.

2. Depending on the available space, either install the pump controller horizontally (Fig. 13) or vertically.
3. Set the pump controller's alignment on the visualisation ↵ “Setting display options” on page 192.



CAUTION!

Pay attention to the latest state of technology, as well as the current accident prevention regulations when installing and removing the pump controller. When drilling the fastening holes to install the pump controller, ensure that the required protective equipment is used.

4.2 Network topologies

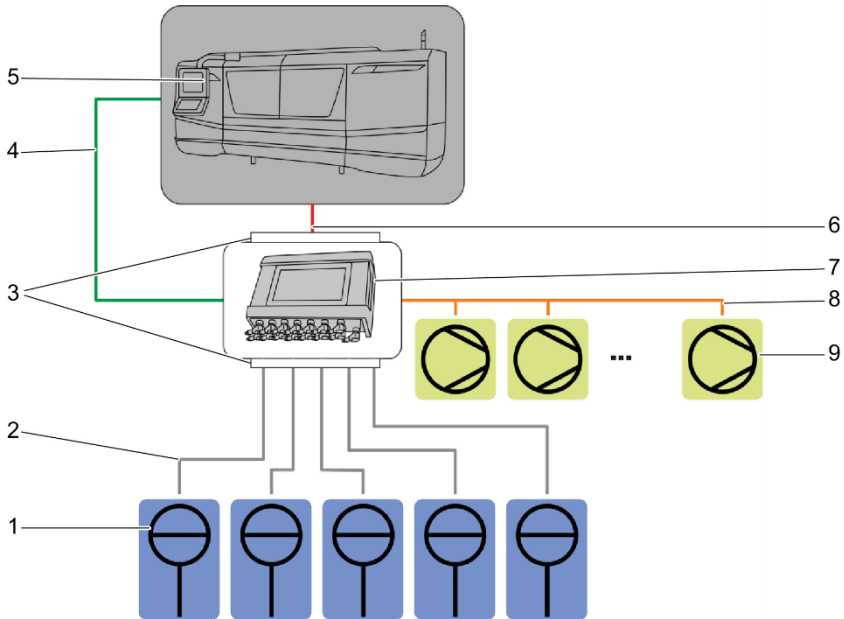

Fig. 14: Network topology

- 1 Sensors/actuators
- 2 Connection line for sensors/actuators (via I/O)
- 3 Analog/digital connections for sensors/actuators
 - ↪ Section 4.3.2.1 "I/O module 1 connection diagram" on page 46 and
 - ↪ section 4.3.2.2 "I/O module 2 connection diagram" on page 47
- 4 Control line 1 ethernet
 - ↪ Section 4.3.2.3 "Power module connection diagram" on page 49
- 5 Machine tool
- 6 Control line 1 I/O connection
 - ↪ Section 4.3.2.1 "I/O module 1 connection diagram" on page 46 and
 - ↪ section 4.3.2.2 "I/O module 2 connection diagram" on page 47
- 7 Pump controller
- 8 Control line 2 Modbus
 - ↪ Section 4.3.2.3 "Power module connection diagram" on page 49
- 9 Pump/frequency converters

The pump controller (Fig. 14/7) is connected to the machine tool that is to be supplied (Fig. 14/5) via control line 1.

Control line 1 can be designed as a standard signal (Fig. 14/6) or field bus connection (Fig. 14/4) by using digital or analog signals. The higher-level controller (e.g. the machine tool's controller) works as the master. The higher-level controller transfers its requirements (e.g. pressure increase) to the pump controller. The pump controller communicates via control line 2 (Fig. 14/8) with the frequency converters for the connected pumps (Fig. 14/9) and exchanges standard signals (0V-10V, 4mA-20 mA (Fig. 14/2) with the connected actuators and sensors (e.g. pressure sensors, valves, Fig. 14/1) via the I/O modules.

4.3 Connecting the pump controller electrically

4.3.1 Basic layout of the I/O level



Illustrations in this operating manual are for basic understanding and may differ from the actual design.

For the individual configuration, see the “Data for setting the bplogic parameters” questionnaire.

The I/O level can be equipped with different I/O modules.

Fig. 15 shows the typical configuration of the pump controller with one I/O module 1 (Fig. 15/A) and one I/O module 2 (Fig. 15/B).

Slot C always contains the same power module (Fig. 15/C).

If a slot is not allocated due to a special configuration, it is sealed using a cover plate.

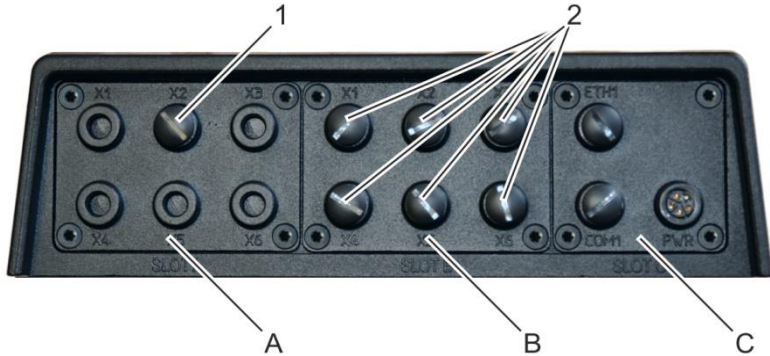

Fig. 15: Typical equipment for I/O modules

- A Slot A with I/O module 1
- B Slot B with I/O module 2
- C Slot C with power module
- 1 12-pin M12 connection for I/O module 1 in slot A
- 2 5-pin M12 connections for I/O module 2 in slot B

4.3.2 Connecting I/O modules

- Staff:
- Manufacturer's assembly staff
 - Electrician
- Materials:
- Service access cover
 - M12 sealing caps



NOTICE!

Risk of damage due to excessive current draw on the I/O modules!

- When connecting, pay attention to the galvanic separation between the actuators and sensors:
 - ↪ *Section 4.3.2.3 “Power module connection diagram” on page 49*
- When connecting sensors and especially actuators, observe the maximum permissible currents per connection and in total:
 - ↪ *Section 4.3.2.3 “Power module connection diagram” on page 49*
 - ↪ *Section 8.3 “Electrical properties” on page 273*
 - ↪ *Section 8.3.2 “I/O module 1” on page 274*
 - ↪ *Section 8.3.3 “I/O module 2” on page 276*

1. Establish the following connections properly according to the pump controller's configuration:
 - Connecting the higher-level controller:
 - ↪ *Section 4.3.2.1 “I/O module 1 connection diagram” on page 46*
 - Connecting sensors and actuators:
 - ↪ *Section 4.3.2.2 “I/O module 2 connection diagram” on page 47*
 - Connecting ethernet, Modbus RTU and the power supply:
 - ↪ *Section 4.3.2.3 “Power module connection diagram” on page 49*



Also see the documentation for the components that are to be connected.



DANGER!

Danger of electric shock due to improper power supply!

The electrical connection may only be established by an electrician.

2. The 24 V power supply must meet the requirements of protective extra-low voltage (PELV) or safety extra-low voltage (SELV protection class III). Connect-

ing the power supply: ↪ *Section 4.3.2.3 “Power module connection diagram” on page 49*

3. Cover unused connections with the enclosed M12 sealing caps in order to ensure the housing’s protection class.
4. Install the safety equipment in accordance with the ↪ *“Further applicable documents” on page 7.*

4.3.2.1 I/O module 1 connection diagram

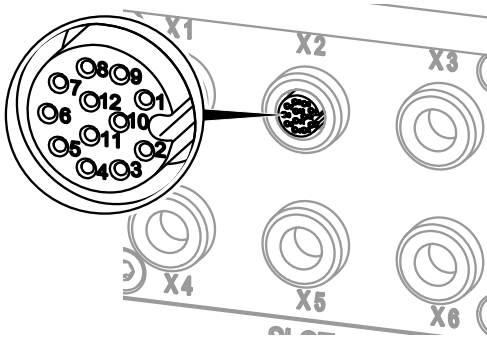

Fig./I/O module 1 connection diagram.svg

Fig. 16: I/O module 1 connection diagram

The M12 plug connections are allocated as follows:

Pin	Allocation
Pin 1	Digital in 1
Pin 2	Digital in 2
Pin 3	Digital in 3
Pin 4	Digital in 4
Pin 5	Digital in 5
Pin 6	Digital in 6/Digital out 1
Pin 7	GND
Pin 8	Analog out 1
Pin 9	Analog in 1
Pin 10	Digital in 7/Digital out 2

Pin	Allocation
Pin 11	Digital in 8/Digital out 3
Pin 12	Digital in 9/Digital out 4



The shielding of the M12 connection is connected to functional earth.

4.3.2.2 I/O module 2 connection diagram

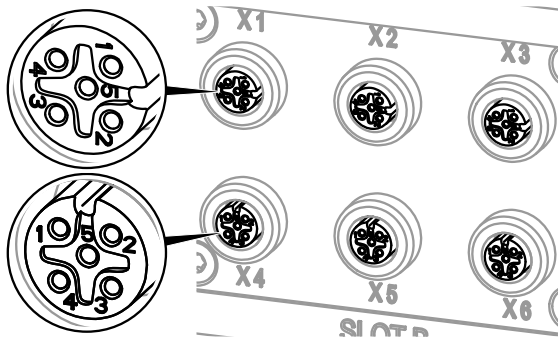







Fig. 17: I/O module 2 connection diagram

Functional earth is connected to PIN 5 and the shielding of each M12 connection.



Also observe the special documentation for information on connecting the sensors and actuators.

The M12 plug connections are allocated as follows:

Pin	X1	X2	X3	X4	X5	X6
1	+ 24 V Sensor	+ 24 V Sensor	+ 24 V Actuator	+ 24 V Sensor	+ 24 V Sensor	+ 24 V Actuator
2	Analog In 1	Digital In 1	Digital Out 1	Analog In 2	Analog Out 1	Digital Out 3
3	GND Sensor	GND Sensor	GND Actuator	GND Sensor	GND Sensor	GND Actuator
4	–	Digital In 2	Digital Out 2	–	–	Digital Out 4
5	FE 	FE 	FE 	FE 	FE 	FE 

Observe the connection values:

- Maximum allowed actuator supply current (total): 1.0 A
- Maximum allowed sensor supply current (total): 1.0 A

4.3.2.3 Power module connection diagram

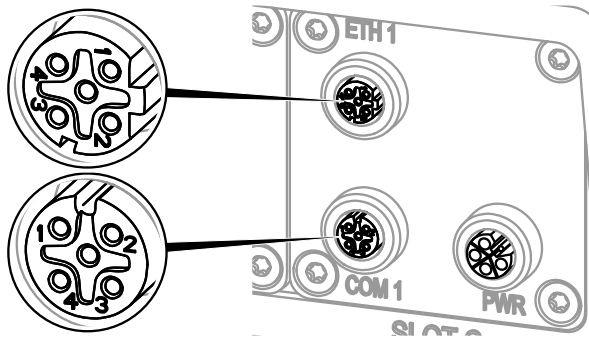

Fig_Connections for power supply.svg

Fig. 18: Power module pin allocation

The connections for the power supply, network and field bus are allocated as follows:

ETH 1: Network

Pin	Allocation
Pin 1	TD+ (transmission data+)
Pin 2	RD+ (receiver data+)
Pin 3	TD- (Transmission Data-)
Pin 4	RD- (Receiver Data-)

COM 1: Modbus

Pin	Allocation
Pin 1	–
Pin 2	RS485/A
Pin 3	–
Pin 4	RS485/B

PWR: Power supply



The 24 V power supply must meet the requirements of protective extra-low voltage (PELV) or safety extra-low voltage (SELV protection class III).

Pin	Allocation
Pin 1	U_A
Pin 2	U_LS
Pin 3	GND_A
Pin 4	GND_LS
Pin 5	FE  1)

1) Also functional earth is connected to the shilding of the M12 connection

**NOTICE!****Operating interruption due to electromagnetic radiation!**

If the functional earth is not connected correctly, pump controller operation may be interrupted by electromagnetic interference.

- Check that the functional earth is connected properly in order to ensure that the pump controller is resistant to electromagnetic interference.

The table uses the following abbreviations:

- A = actuators
- LS = logic and sensors

Observe the connection values:

- Maximum allowed input current for actuators I_{Amax} : 14 A
- Maximum allowed input current for logic and sensors I_{LSmax} : 4 A

5 Operating the pump controller

Initial commissioning

Many settings are pre-configured by the manufacturer to enable initial commissioning by the operator.

1. Switch the pump controller on ↪ *Section 5.1 ‘Switching on and logging in’ on page 52.*
2. Use the login screen to log in ↪ *Section 5.1 ‘Switching on and logging in’ on page 52.*
3. Once initial commissioning is complete, please verify that the configuration settings made by the manufacturer are correct and adjust if necessary.
4. If there should be any issues with the configuration, contact customer service:
 - To do this, provide the current configuration file ↪ *Section 7.2.1 ‘Backup and restore preparation on page 250.*
 - Or:
 - Have the pump controller’s order number and serial number at hand ↪ *‘Customer service’ on page 8.*

5.1 Switching on and logging in

1. Establish the power supply. To do this, connect the pump controller’s PWR connection to the power supply using an L-coded M12 connection line.
 - ⇒ The pump controller starts. A progress bar shows the process that is running.
2. Observe the following boot sequence when using removable storage devices:
 - external USB storage medium
 - external micro SD card
 - internal flash memory
 - ⇒ After start-up, the login screen is displayed (Fig. 19).



Fig. 19: Login screen

3. Log in to the active pump controller with a user name and password (Fig. 19).

User name	Password
admin	Admin123
service	Service123
operator	Operator123

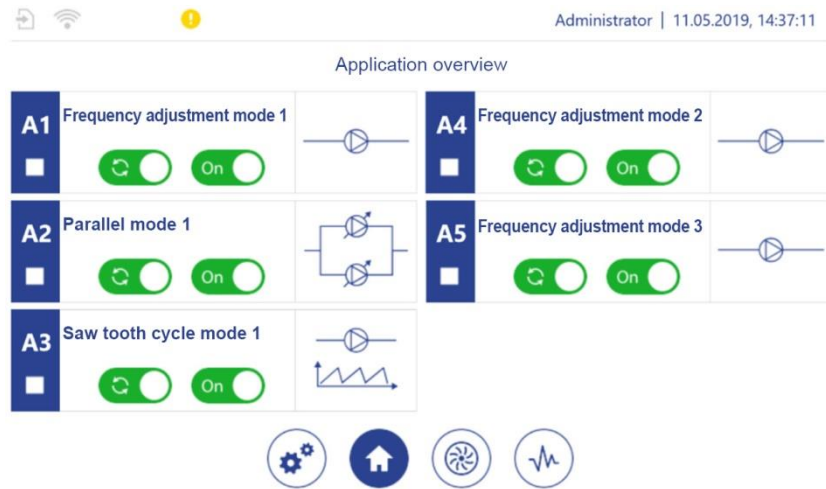

AM_primary functions_not revised.png

Fig. 20: Application overview

⇒ The application overview (Fig. 20) opens.

4. Read and acknowledge any warnings that occur:

↳ [Section 7.3 “Event messages” on page 260](#)

5.1.1 Optional pump controller operation via remote access

You can operate the pump controller directly using the touchscreen or via remote access using a web browser. Remote access enables you to operate the pump controller even if the touchscreen may be difficult to access, e.g. because the pump controller is installed permanently in a switch cabinet.

Several users at a time can be logged in to the pump controller via remote access:

- You can log in to the pump controller via remote access even if a user is already operating the pump controller via the touchscreen.
- You can log in via the touchscreen on the pump controller even if a user is already operating the pump controller via remote access.

If multiple users are logged in to the pump controller at the same time, only the first user that logged in receives write permissions. Only a user with write authorisation can adjust the pump controller’s settings and operate the pump controller actively.

An ethernet connection or a WLAN connection is required for remote access. In order to use remote access, you must call the pump controller's login screen using a web browser. To do this, you must open a web address according to the following template:

- `http://xxx.xxx.xxx.xxx:8080/web.htm`
- `http://xxx.xxx.xxx.xxx:8080/webvisu.htm`

When you open one of the web addresses, you must replace “xxx.xxx.xxx.xxx” with the IP address of your pump controller.

Example:

If your pump controller has the IP address “192.168.1.100”, you must open the web address “192.168.1.100:8080/web.htm” or “192.168.1.100:8080/webvisu.htm”.



Configuring the network settings

The pump controller's network settings including the IP address are pre-configured by the manufacturer according to your specifications. You can change the network settings at any time after initial commissioning.

- ↪ *Section 5.6.3 “Setting LAN parameters” on page 202.*
- ↪ *Section 5.6.4 “Setting WLAN module parameters” on page 205.*

The web address ending in “web.htm” is intended for remote access using a device with a keyboard, e.g. a laptop or a desktop PC. If you access the pump controller via the web address ending in “web.htm”, you can use the keyboard to type values into the input fields in the pump controller's software.

The web address ending in “webvisu.htm” is intended for remote access using a device without a keyboard, e.g. a tablet. If you access the pump controller via the web address ending in “webvisu”, an on-screen keyboard opens as soon as you tap an input field.

1. Turn on the pump controller.
2. Use a web browser to call the pump controller's web address.
 - ⇒ The login screen is displayed.



Alternatively, you can open the web address ending in “webvi-su.htm” by scanning the QR code in the WLAN settings for your pump controller. The web address is opened directly in your web browser.

↳ Section 5.6.4 “Setting WLAN module parameters” on page 205.

5.2 Operating principles

5.2.1 General screen layout

All software displays are laid out according to the following principle.

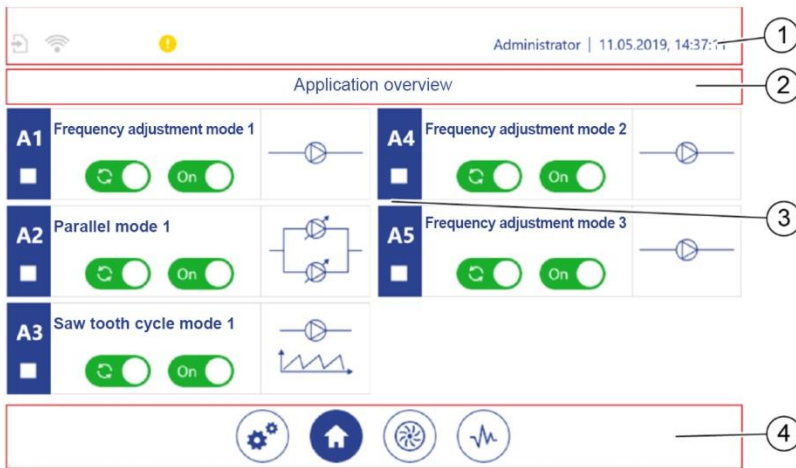

AlM6_Screen_layout-01.png

Fig. 21: Screen layout









- 1 Status bar The status bar shows information regarding the current system status. It enables you to call the “Quick access” dialogue and the “*Event list*” menu (↪ *section 5.2.2 “Status bar” on page 58*).
- 2 Title bar The title bar displays the name of the current menu. It enables you to return to the main menu from every display (↪ *section 5.2.3 “Title bar” on page 59*).
- 3 Main screen The main screen displays the contents of the current menu (↪ *section 5.2.5 Main screen” on page 62*).
- 4 Navigation bar The jump icons in the navigation bar enable you to switch between adjacent displays and menus (↪ *section 5.2.4 “Navigation bar” on page 59*).

5.2.2 Status bar

The following overview describes all icons and display elements that may be shown in the status bar.



Fig. 22: Status bar

- | | | |
|---|--------------------------|--------------------------------------------------------------------------------------------------------------------------------------------------------------------------------------------------------------------------------------------------------------------------------------------------------------------------------------------------------------------------------------------------------------------------------------------------------------------------------------------------------------------------------------------------------------------------------------------------------------------------------------------------------------------------------|
| 1 | “Logging on/off” button | <p>Meaning of the possible colours:</p> <ul style="list-style-type: none"> • : Long-term logging is activated. • : Long-term logging is deactivated. <p>The “Logging on/off” button opens the “Quick access” dialogue. This dialogue enables you to activate and deactivate long-term logging and the WLAN for example.</p> |
| 2 | “WLAN on/off” button | <p>Meaning of the possible colours:</p> <ul style="list-style-type: none"> • : WLAN is activated and can be used. • : WLAN is deactivated. <p>The “WLAN on/off” button opens the quick start dialogue. This dialogue enables you to activate and deactivate long-term logging and the WLAN for example.</p> |
| 3 | “Event list” button | <p>Meaning of the icons and colours:</p> <ul style="list-style-type: none"> • : System event information is present. • : A warning message is present. • : An error message is present. • : There are no event messages. <p>The “Event list” button opens the “<i>Event list</i>” menu.</p> |
| 4 | “Logged in user” display | Displays the username of the logged in user |
| 5 | “Date and time” display | Displays the current date and the current time |

5.2.3 Title bar

The following overview describes all icons and display elements that may be shown in the title bar.



Title_bar-01.png

Fig. 23: Title bar

- | | | |
|---|---------------------|-----------------------------------------------------------------------------------------------------------------------------------------------------------|
| 1 | “Back” button | Navigates back to the last screen |
| 2 | “Menu name” display | Displays the name of the current menu |
| 3 | “Home” button | Enables you to return to the main menu level from any submenu level within the software. The main menu from which the main menu level was left is called. |
| 4 | “Full view” button | Opens the full view in the “Application oscilloscope” main menu |

5.2.4 Navigation bar

The jump icons that are displayed in the navigation bar represent all available adjacent menus for a menu level. The jump icons are buttons that you can use to jump to any other menu in the same menu level. The amount and type of jump icons displayed in the navigation bar is menu-specific.

The navigation bar is available in the following menus:

- All of the main menu level menus (↪ *section 5.2.11 “Main menu overview” on page 83*)
 - Configuration (↪ *section 5.2.11.1 “Menu overview for the “Configuration” menu” on page 84*)
 - Application overview
 - Pump overview
 - Application oscilloscope
- Application single view
- Pump single view

Navigation bar jump icons in the main menus

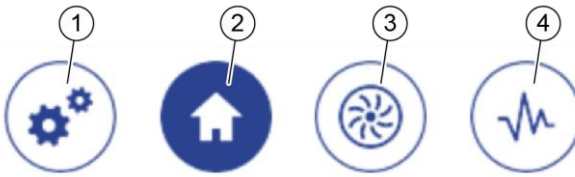

Navigation_bar_main_menu_level-01.png

Fig. 24: Main menu navigation bar

- 1 Calls the “Configuration” main menu
- 2 Calls the “Application overview” main menu
- 3 Calls the “Pump overview” main menu
- 4 Calls the “Application oscilloscope” main menu

The current main menu that is displayed on the main screen is highlighted by the jump icon’s colours being inverted (Fig. 24/2).

Navigation bar jump icons in the individual views

You can use the jump icons to switch between the application single view (Fig. 25/1) and the pump single views for the available pumps (Fig. 25/2).

The number of jump icons displayed depends on the application module that is displayed. The navigation bar displays a jump icon for each pump that is assigned to the application module. Up to 6 pumps can be assigned to an application module.

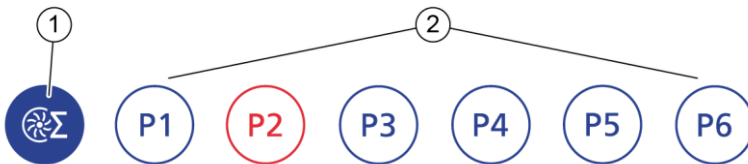





Navigation_bar_single_view-01.png

Fig. 25: Navigation bar for the single views

- 1 Calls the application single view
- 2 Calls the pump single views for the pumps that are available

Meaning of the colours for the jump icons

Display	Description	Meaning
	Blue	Indicates that the pump is ready for operation
	Red	Indicates that there is a fault on the pump
	Yellow	Indicates that a pump is in maintenance mode or that the pump may have to be maintained due to wear
	Inverted colours	Marks the current single view

5.2.5 Main screen

The main screen shows the contents of the menus that are called and enables values to be adjusted or functions to be executed within the menus.

In the *Application single view* and *Pump single view* menus, the main screen is divided into 2 display areas (Fig. 26/1–2).

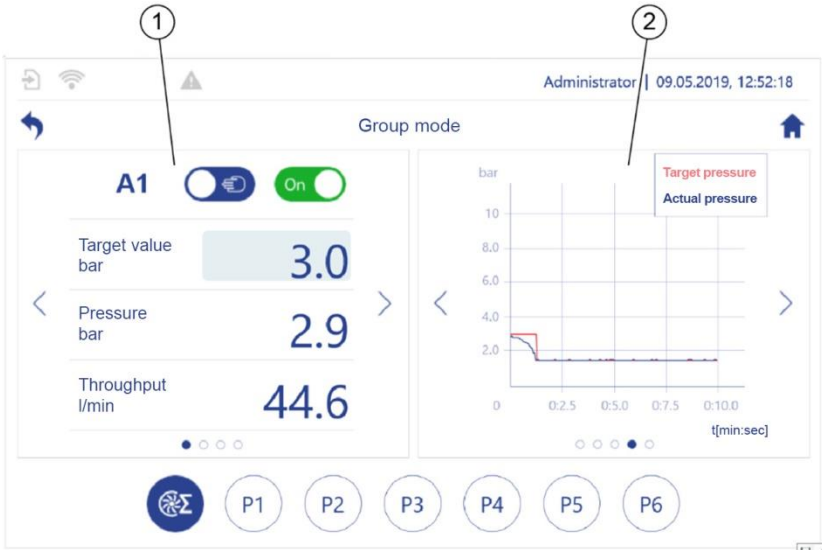







Main screen_display areas-01.png

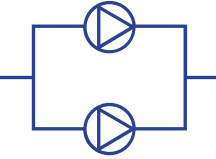
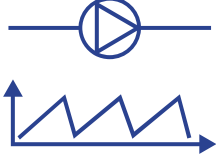
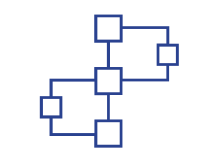





Fig. 26: Display areas for the single views

















- | | | |
|---|--------------------|------------------------------------------------------------------------------|
| 1 | Left display area | • Enables settings to be made and pre-set parameter values to be checked |
| 2 | Right display area | • Displays information regarding the current status and the pump performance |





Buttons and navigation elements

The following overview describes all buttons and navigation elements that may be shown on the main screen. The buttons and navigation elements can be tapped.

Icon	Function
	Call the previous menu or display area screen
	<ul style="list-style-type: none"> • Call the next menu or display area screen. • In the “Configuration” menu: call the next menu level
	<p>Scroll bar:</p> <ul style="list-style-type: none"> • Touchscreen: tap the white bar to scroll • PC: click the white bar or press and hold the blue area and drag to scroll
	<p>Pump:</p> <ul style="list-style-type: none"> • Indicates that the application module is controlling a pump in adjustment mode. • Opens the application single view
	<p>Pump, controlled:</p> <ul style="list-style-type: none"> • Indicates that the application module is controlling a pump in control mode • Opens the application single view
	<p>Pressure increase:</p> <ul style="list-style-type: none"> • Indicates that the application module is controlling a pump group with the “Pressure increase” primary function • Opens the application single view

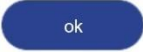





Icon	Function
	<p>Parallel mode:</p> <ul style="list-style-type: none"> Indicates that the application module is controlling a pump group in parallel mode Opens the application single view
	<p>Saw tooth cycle mode:</p> <ul style="list-style-type: none"> Indicates that the application module is controlling a pump in saw tooth cycle mode Opens the application single view
	<p>Logic module:</p> <ul style="list-style-type: none"> Indicates that the application module is configured as a logic module. Opens the application single view
	<p>In the “Event list” menu: deletes all entries from the event list</p>
	<ul style="list-style-type: none"> Displays a selected setting The selection can be deselected by tapping
	<ul style="list-style-type: none"> Displays a selectable setting The setting can be deselected by tapping
	<ul style="list-style-type: none"> For a multiple selection: displays a selected setting The selection can be deselected by tapping
	<ul style="list-style-type: none"> For a multiple selection: displays a selectable setting The setting can be deselected by tapping
	<ul style="list-style-type: none"> Indicates that the adjacent parameter is not selected Selects the adjacent parameter and saves the selection

Icon	Function
	<ul style="list-style-type: none"> Indicates that the adjacent parameter is selected Removes the selection
	Shows a dropdown list
	Increases a value by 1
	Decreases a value by 1
	<ul style="list-style-type: none"> Indicates that the application oscilloscope is paused Starts the paused application oscilloscope
	<ul style="list-style-type: none"> Indicates that the application oscilloscope is active Pauses the active application oscilloscope
  	Saves the settings changed in the current menu
	<p>Cancel</p> <p>Cancels the current process without saving changed settings or values.</p>
	<p>Browse</p> <p>Calls the file manager</p>
	<p>Start</p> <p>Starts a function, e.g. data backup</p>
	<p>Copy</p> <p>Starts a copying process</p>
	<p>Eject</p> <p>Ejects the desired storage device</p>
	<p>Start export...</p> <p>Starts a file export</p>
	<p>Start import...</p> <p>Starts a file import</p>

Icon	Function
	Closes a dialogue box
	Acknowledges an event message
	Closes an event message without acknowledging
	Opens a dialogue box that displays the contents of the adjacent input field completely, e.g. a parameter's path.







Software switch

The following overview describes all software switches that may be shown on the main screen.

Switch	Icon	Function
On/off		Indicates that the function displayed is activated
		Indicates that the function displayed is deactivated
Automatic mode/manual mode		Indicates that automatic mode is activated for the application module displayed
		Indicates that manual mode is activated for the application module displayed
Channel shown/ Channel hidden		<ul style="list-style-type: none"> Indicates that the channel is shown in the application oscilloscope The channel can be hidden by tapping the software switch
		<ul style="list-style-type: none"> Indicates that the channel is hidden in the application oscilloscope The channel can be shown by tapping the software switch

Display elements

The following overview describes all display elements that may be shown on the main screen. Display elements are for information only and cannot be tapped.

Icon	Function/meaning
	<ul style="list-style-type: none"> • Blue: the screen that is currently displayed for a menu or display area • Grey: adjacent screen to the current screen that is displayed <p>The number of circles corresponds to the number of screens in the current menu or display area that is called.</p>
	<p>“Info”: indicates that there is new information for an application module or a hardware component</p>
	<p>“Warning”: indicates that there is a warning for an application module or a hardware component</p>
	<p>“Fault”: indicates that there is a fault on an application module or a hardware component</p>
	<p>“On”: indicates that the hardware component that is displayed is ready for operation</p>
	<p>“Off”: indicates that the hardware component that is displayed is not ready for operation</p>

5.2.6 Dialogue: “Quick access”





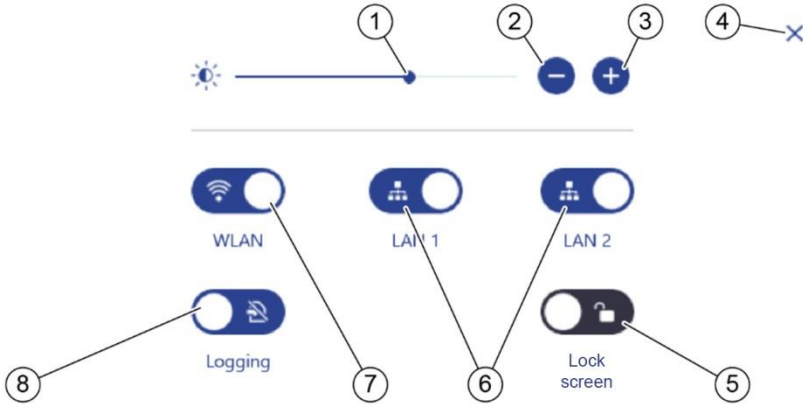

You can call the “Quick access” dialogue at any time via the “WLAN on/off” or “Logging on/off” buttons in the status bar or by swiping (↩ *Section 5.2.7.2 “Swiping” on page 71*). The dialogue is shown in a dialogue box without you having to leave a menu.

If you have configured a network connection for the pump controller, you can activate and deactivate this using the software switch in the “Quick access” dialogue (Fig. 27/6 – 7. Also see: ↪ [Section 5.6.3 “Setting LAN parameters” on page 202](#) and ↪ [section 5.6.4 “Setting WLAN module parameters” on page 205](#)).



Settings-menu-01.png

Fig. 27: “Quick access” dialogue

- 1 Displays the current screen brightness
- 2 Reduces the screen brightness
- 3 Increases the screen brightness
- 4 Closes the “Quick access” dialogue
- 5 Logs the user out of the system and calls the lock screen
- 6 : establishes a connection to the network displayed (LAN 1 or 2)
: disconnects the connection to the network displayed (LAN 1 or 2)
- 7 : establishes a WLAN connection
: disconnects the WLAN connection
- 8 : activates the “Long-term logging” function (↪ [section 6.1 “Using logging” on page 240](#))
: deactivates the “Long-term logging” function

5.2.7 Navigation

You can operate the pump controller both via the pump controller’s touchscreen and from a tablet or PC.

5.2.7.1 Buttons

You can use buttons to navigate within the pump controller’s menus. All buttons that are used for navigation are active at all times. This means that you can always tap this button to call a different menu or to return to the previous view.

Software switch

The pump controller also has some special buttons, the software switches. All software switches have two states, e.g. “On” and “Off” (Fig. 28). They are used to activate and deactivate functions and application modules, as well as to switch the application modules from automatic mode to manual mode.



Switch states_ example-01.png

Fig. 28: Example: the two states of an “On/Off” software switch

- ▶ Tap a switch in order to change its state.

Inactive buttons

Inactive buttons cannot be tapped. Inactive buttons are greyed out (Fig. 29/1).

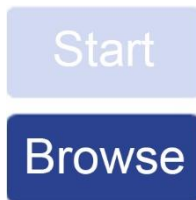

Button_active_inactive-01.PNG

Fig. 29: Example: inactive buttons and active buttons

5.2.7.2 Swiping

When operating using a device with a touchscreen, the following swiping options are also available to you.

Horizontal swiping

The horizontal swiping options are only available to you in the main menu level (↩ section 5.2.11 “Main menu overview” on page 83).

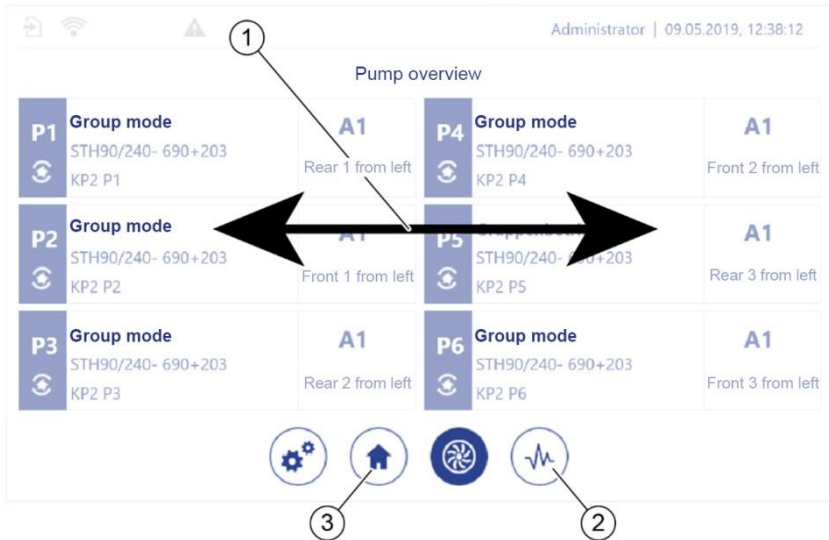

Horizontal_swiping-01.png

Fig. 30: Horizontal swiping

- Swipe horizontally (Fig. 30/1) to display the adjacent main menu on the same hierarchy level (Fig. 30/2 or 3).

Vertical swiping

Swipe downwards to open the “Quick access” dialogue. The option to swipe downwards is available to you in all of the pump controller’s views and menus. Swipe upwards to close the “Quick access” dialogue. The option to swipe upwards is only available to you in this dialogue.

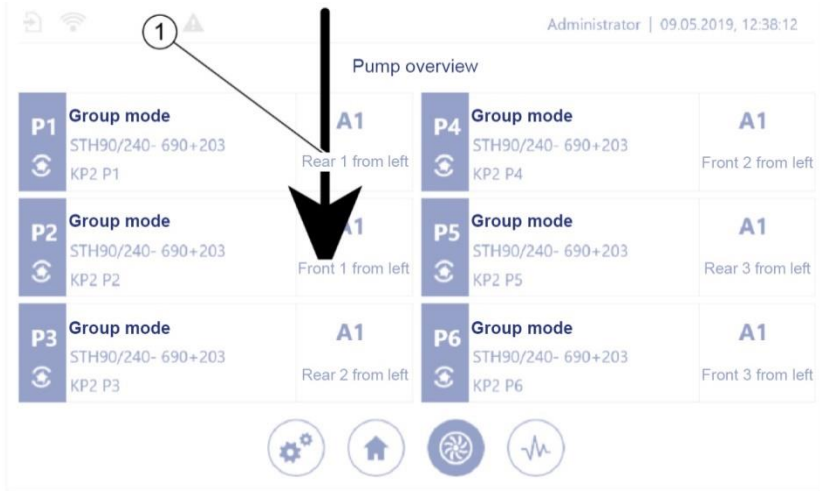

Vertical_downwards-swiping-01.png

Fig. 31: Vertical swiping

1. Swipe downwards (Fig. 31/1) to show the “Quick access” dialogue.
⇒ The “Quick access” dialogue (Fig. 32) opens.

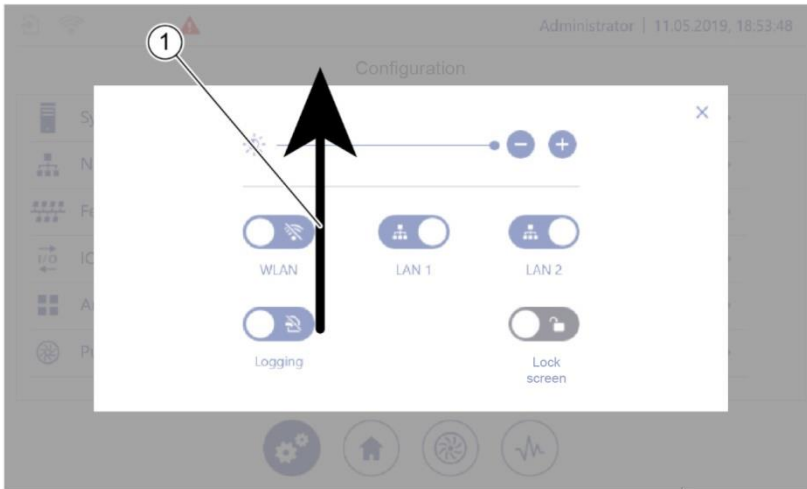

Vertical_upwards-swiping-01.png

Fig. 32: “Quick access” dialogue

2. Swipe upwards (Fig. 32/1) to hide the “Quick access” dialogue again.

5.2.8 Input helps

You can edit some process and system parameters. A value that can be edited is in a tappable input field (Fig. 33/1). Tapping the required value opens an input help such as the alphanumeric on-screen keyboard. The input help that opens depends on the type of the applicable value.

You cannot edit input fields that contain greyed out values (Fig. 33/2).

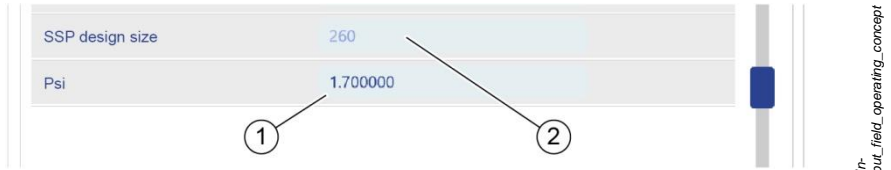

Fig. 33: Input fields with changeable and unchangeable values

Greyed out values cannot be changed for various reasons:

- The system calculates the values.
- The values relate to an activated application module. You can only change the values once the application module has been deactivated.
- The values are pre-specified by the manufacturer in accordance with their specification in the configuration file. Only the manufacturer can edit the configuration file.

5.2.8.1 On-screen keyboards

The pump controller's on-screen keyboards enable values to be entered if the pump controller is being operated via the touchscreen.

After tapping the input field, either the alphanumeric or the numeric on-screen keyboard opens depending on the context. The numeric on-screen keyboard is used to enter numbers and mathematical operators. The alphanumeric on-screen keyboard is used to enter letters, numbers and special characters.

- ▶ Tap an editable input field.
 - ⇒ The alphanumeric or the numeric on-screen keyboard opens depending on the context.

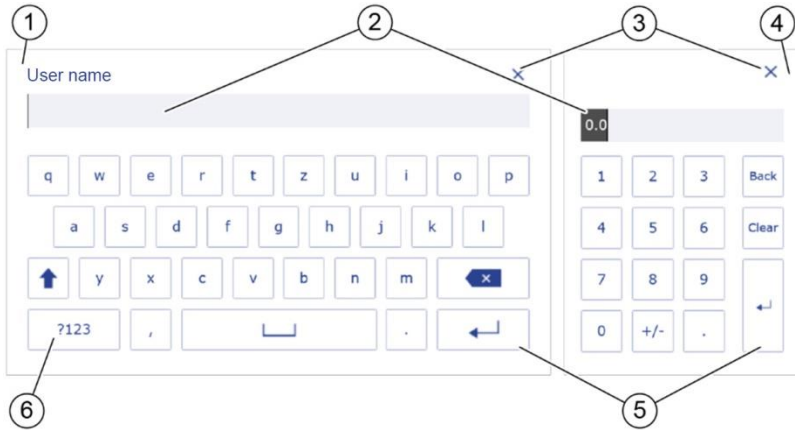

Alphanumeric_numeric_keyboards-01.png

Fig. 34: On-screen keyboards

- | | | | |
|---|-----------------------------------------------------|---|----------------------------------------------------|
| 1 | Alphanumeric keyboard | 4 | Numeric keyboard |
| 2 | Input field | 5 | Enter key: closes the keyboard and saves the entry |
| 3 | Close: closes the keyboard without saving the entry | 6 | Switch number input |

5.2.8.2 Dropdown lists

Dropdown lists are used to quickly select values specified by the system. You can select list entries by tapping.

1. ✓ or tap the input field for which you wish to set a value.
 - ⇒ A dropdown list opens.

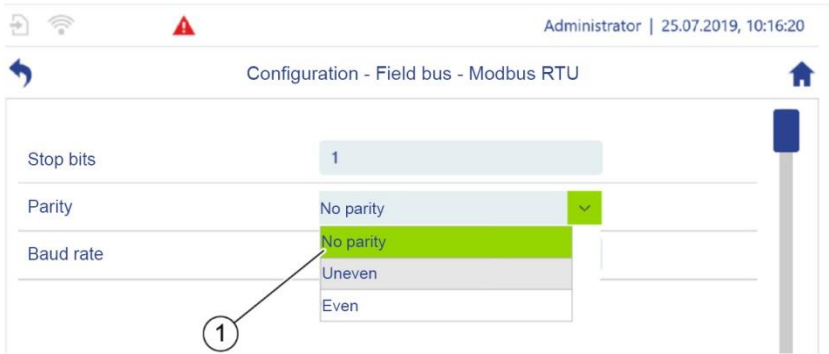

Dropdown_list_example-01.png

Fig. 35: Example: Dropdown list

- ⇒ The list entry that is currently set for the input field has a green background (Fig. 35/1).
2. Tap the desired list point.
 - ⇒ The list entry is selected and saved.
 - ⇒ The dropdown list closes automatically after selection.

5.2.8.3 Parameter selection

Parameter selection supports you when setting the parameters for certain pump controller functions. These functions, e.g. setting the parameters for the logic module, require you to define a pump controller parameter as the value for an input field.

Parameter selection opens a menu structure that is identical to the menu structure for the “*Configuration*” menu (☞ [section 5.2.11.1 “Menu overview for the “Configuration” menu” on page 84](#)).

For information on the parameters that you can select using parameter selection, see the parameter list.

Selecting parameters

1. Tap the input field for which you wish to set a parameter.
 - ⇒ Parameter selection opens:
 - If a parameter is not yet defined for the input field, parameter selection displays the highest level of the “*Configuration*” menu (Fig. 36)
 - If a parameter is already defined for the input field, parameter selection displays the submenu of the “*Configuration*” menu (Fig. 37), which contains this parameter.

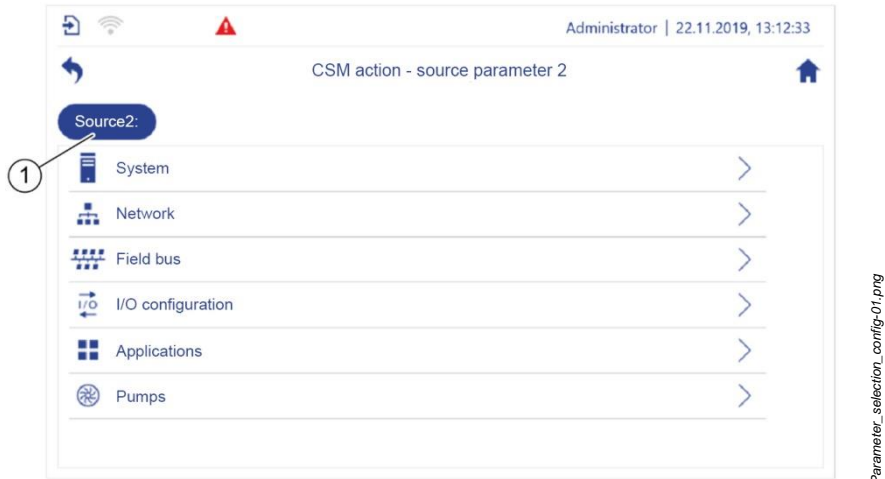

Fig. 36: Parameter selection

- ⇒ Parameter selection displays the name of the input field that you tapped (Fig. 36/1).
2. In parameter selection, navigate to the submenu that contains the required parameter.



Save_parameter_selection-01.png

Fig. 37: Selecting parameters

3. Tap next to the required parameter ✓ (Fig. 37/1).
 - ⇒ The input field saves the parameter.
 - ⇒ Parameter selection closes automatically.

Deleting parameters from input fields

You can use parameter selection to delete parameters from input fields.

1. Tap the input field for which you wish to delete a parameter.
 - ⇒ Parameter selection (Fig. 38) displays the menu that contains the parameter displayed in the input field.
 - ⇒ Parameter selection indicates the parameter displayed in the input field with ✓ (Fig. 38/1).

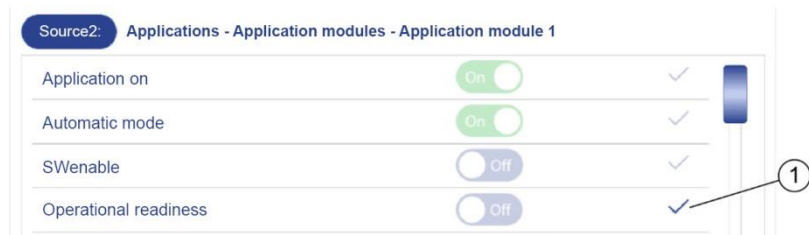



Delete_parameter_selection-01.png

Fig. 38: Removing selection

2. Tap next to the marked parameter ✓.
 - ⇒ The parameter is removed from the input field.
 - ⇒ Parameter selection closes automatically.

Cancelling parameter selection

You can close parameter selection at any time when it is open without selecting a parameter.

- ▶ Tap  in parameter selection.
 - ⇒ Parameter selection closes and the “*Configuration*” menu is displayed.
- ▶ In parameter selection, use  to navigate back until parameter selection closes automatically and the menu from which you opened parameter selection is displayed.

5.2.9 Global data

Global data is predefined data with values that you can select freely. You can use parameter selection to assign the value of an item of global data to a parameter. This way, you can specify global data as concrete target values in application modules for example.

The global data is primarily intended to be intermediate storage (a marker) for logic module results. However, field bus information can be stored in global data and processed further by the logic module.

You must assign one of the following data types to each piece of global data:

Data type	Description
BOOL	The BOOL data type is a binary signal. A binary signal can only express two states. Global data with the BOOL data type saves the “on” or “off” state. It is therefore suitable for transferring limit switch signals, e.g. to indicate operational readiness for an application module.
UDINT	Global data with the UDINT data type is suitable for saving values using analog signals. A piece of global data with the UDINT data type can contain any whole number without a mathematical sign and is therefore suitable for specifying target values.
REAL	Global data with the REAL data type is suitable for saving values using analog signals. A piece of global data with the REAL data type can contain any floating-point number and is therefore suitable for specifying target values.

5.2.9.1 Configuring global data

Only the following user groups can assign values to global data:

- Service
- Admin

1. In “*Configuration*”, tap “*System*”.
⇒ “*Configuration – System*” opens.
2. Tap “*Global data*”.
⇒ “*Configuration – System – Global data*” (Fig. 39) opens.



Configuration_Global-data-01.png

Fig. 39: “*Configuration – System – Global data*”

3. Select the required data type for the piece of global data. To do this, tap the corresponding submenu:
 - “*BOOL variables*” (Fig. 39/1)
 - “*UDINT variables*” (Fig. 39/2)
 - “*REAL variables*” (Fig. 39/3)

BOOL variables Assigning/pre-initialising values

1. If the variable is to have the “on” state, set the software switch for the required piece of global data to *On*.
2. If the variable is to have the “off” state, set the software switch for the required piece of global data to *Off*.

UDINT variables Assigning/pre-initialising values

- ▶ Enter a whole number without a mathematical sign in the input field for the required piece of global data.

REAL variables Assigning/pre-initialising values

- ▶ Enter a floating-point number in the input field for the required piece of global data.

5.2.10 File manager

You can use the file manger to select files or file paths for file operations such as copying, saving or loading.

1. In “*Configuration – System – Backup & Restore*”, tap “*File operations*”.
 - ⇒ “*Configuration – System – Backup & restore – File operations*” (Fig. 40) opens.

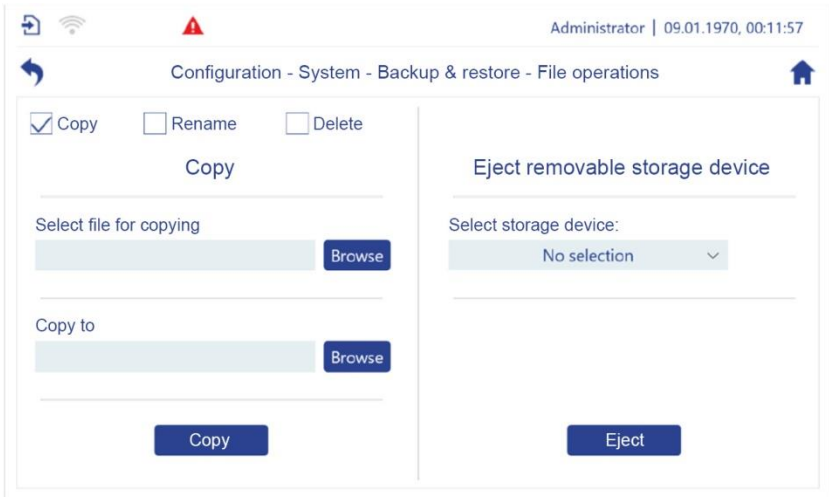

Config_System_File-operations.png

Fig. 40: “*File operations*”

- ▶ Tap the “Browse” button to open the file manager.

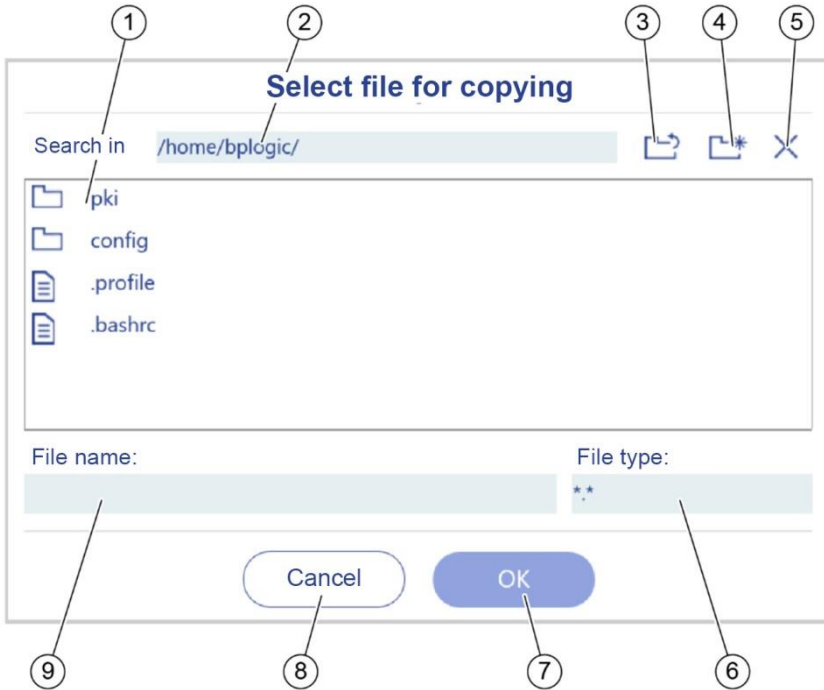

File-manager_Backup-Restore-01.PNG

Fig. 41: File manager

- 1 Contents of the current folder
- 2 Current path
- 3 Open higher level folder
- 4 Create new folder
- 5 Delete selected item
- 6 File type
- 7 Execute action (load, save, delete, etc.)
- 8 Cancel
- 9 File name

5.2.11 Main menu overview

You can use the four main menus (Fig. 42/2–5) to call all views and menus to set parameters and monitor the system components.

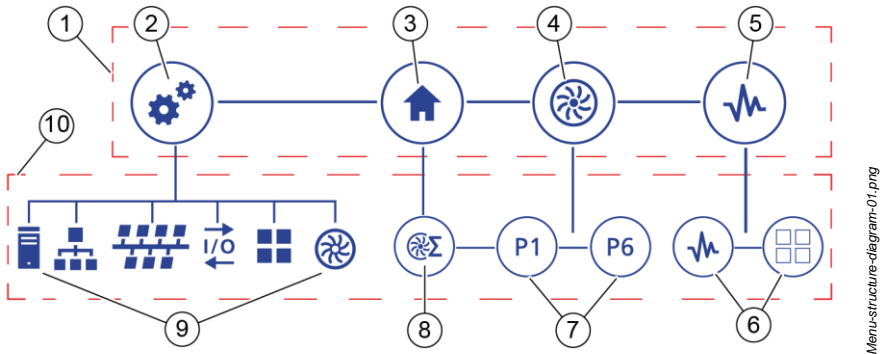

Fig. 42: Menu structure (diagram)

- | | | |
|---|--------------------------|----------------------------------------------------------------------------------------------------|
| 1 | Main menu level | |
| 2 | “Configuration” menu | You can use the submenus in the “Configuration” menu to make all system settings. |
| 3 | Application overview | The application overview provides an overview of all available application modules. |
| 4 | Pump overview | The pump overview provides an overview of the status of all connected pumps. |
| 5 | Application oscilloscope | The application oscilloscope displays process parameters as a flow diagram. |
| 6 | Oscilloscope | In the “Oscilloscope” view, you can switch between the flow diagram display and the value display. |
| 7 | Pump single views | The pump single views display details regarding the desired pump. |
| 8 | Application single view | The application single view displays details regarding the desired application module. |

- 9 Setting menus for system components You can use the submenus in the “Configuration” menu to make and check the system settings for all system components.
- 10 Submenu level

5.2.11.1 Menu overview for the “Configuration” menu

The following menu overview describes all submenus that can be called using the “*Configuration*” main menu.

Level 1	Level 2	Level 3	Description
System	General		Defines the following basic settings: <ul style="list-style-type: none"> • Type of displayed system parameter • The system language • The screen rotation • The time after which the user is logged out automatically • The maximum file sizes for the event log CSV file and the archive CSV file
	Logging		<ul style="list-style-type: none"> • Activates/deactivates long-term logging. • Defines the settings for long-term logging
	Unit change		Defines the units for displaying the process sizes
	Date & time		Sets the date and time
System	User administration	Password change	Changes the user passwords

Level 1	Level 2	Level 3	Description
	Backup & Restore	Application	Backs up and restores the application software
		System	Backs up and restores the complete system software
		Settings	Backs up and restores all setting parameters
		File operations	Can rename files, delete them and copy them to an external storage device
		Up-/Download	Can download files from the pump controller onto a networked PC and upload files from a networked PC to the pump controller
	Device restart		Restarts the device
	Global data	BOOL variables	Provides up to 32 variables for values with the BOOL file type
		UDINT variables	Provides up to 32 variables for values with the UDINT file type
		REAL variables	Provides up to 32 variables for values with the REAL file type
	Network	Ethernet 1 (M12)	
Ethernet 2 (RJ45)			Defines the network address for the ethernet connection on the service module

Level 1	Level 2	Level 3	Description
	WLAN Server		Sets up a WLAN connection
	NTP server		Defines whether the date and time are based on an NTP server or set manually
Field bus	General	Field bus selection	Displays the type of field bus used
		BOOL mapping PLC → BPL	Defines the parameters for which values are sent from the machine controller to the pump controller.
		UDINT mapping PLC → BPL	
		REAL mapping PLC → BPL	
Field bus	General	BOOL mapping BPL → PLC	Defines the parameters for which values are sent from the pump controller to the machine controller.
		UDINT mapping BPL → PLC	
		REAL mapping BPL → PLC	
	Modbus RTU		Sets the Modbus RTU

Level 1	Level 2	Level 3	Description
	Profinet		<ul style="list-style-type: none"> Only available with the PROFINET option. Configures the PROFINET I/O field bus.
	EtherNet/IP		<ul style="list-style-type: none"> Only available with the EtherNet/IP option. Configures the EtherNet/IP field bus.
I/O configuration	General		Indicates the number of I/O modules that are available
	I/O module 1... (the submenus are each available for every I/O module that is connected)	General	Displays status and system information regarding the I/O module
		Digital inputs	Sets parameters for all available digital inputs for the module individually
		Digital outputs	Sets parameters for all available digital outputs for the module individually
I/O configuration	I/O module 1... (the submenus are each available for every I/O module that is connected)	Analog inputs	Sets parameters for all available analog inputs for the module individually
		Analog outputs	Sets parameters for all available analog outputs for the module individually
	Frequency converter 1... (the submenus	General	Displays status and system information regarding the frequency converter

Level 1	Level 2	Level 3	Description
	are each available for the frequency converter for each pump that is connected)	Digital inputs	Sets parameters for all available digital inputs for the frequency converter individually
		Digital outputs	Sets parameters for all available digital outputs for the frequency converter individually
		Analogue inputs	Sets parameters for all available analog inputs for the frequency converter individually
		Analog outputs	Sets parameters for all available analog outputs for the frequency converter individually
Applications	Application modules	General	Displays the quantity and numbers of the available application modules
Applications	Application modules	Application module 1... (this menu is available for all application modules)	Displays the submenus available for the application module. (☞ section 5.2.11.2 “Menu overview for the “Application module” menu” <i>on page 90</i>).
	Primary functions	Name of the primary function	Sets the parameters for the primary function
	Secondary functions	Name of the secondary function	Sets the parameters for the secondary function

Level 1	Level 2	Level 3	Description
Pumps	Pump 1... (the submenus are each available for every pump that is connected)	General	Displays status and system information regarding the pump
		Hydraulics	Sets parameters for the pump's hydraulics
		Motor	Displays the parameter values for the pump's motor
		Frequency converter	Sets parameters for the pump's frequency converter

5.2.11.2 Menu overview for the “Application module” menu

The “Application module” menu is a submenu of the “Configuration” menu. This menu is available for all pump controller application modules.

Level 1	Level 2	Description
Application module 1...	Overview	<ul style="list-style-type: none"> • Activates or deactivates the application module • Displays the parameter settings for the application module. Some parameter settings can be changed.
	Favourites	<ul style="list-style-type: none"> • Activates or deactivates the favourites display for this application module • Defines up to 8 parameter values as favourites for this application module
	Secondary functions	Indicates the secondary functions that are set in the application module. The parameters for the set secondary functions are provided in the configuration menu for the corresponding secondary function (↪ section 5.2.11.1 “Menu overview for the “Configuration” menu” on page 84).
	Pumps	Indicates which pumps are assigned to the selected application module. The parameters cannot be changed.

5.3 Application modules

The pump controller can execute up to six applications simultaneously. To do this, the pump controller provides up to six application modules in which predefined main functions can be selected and executed. The predefined main functions are designated as primary functions. A primary function can be for example a pressure regulation comprising two pumps.

The primary function assigned can be expanded with secondary functions. Secondary functions are extension functions for an application.

Up to 6 application modules can be active at the same time. One application module is able to control up to 6 pumps.

An application module contains the following components:

Component	Description
Primary function	The main function of the application module, e.g. "Pressure increase" (↪ <i>section 5.4 Primary functions on page 100</i>).
Secondary function	A function that is assigned to a primary function, e.g. "Offset control" (↪ <i>section 5.5 Secondary functions on page 158</i>). Secondary functions are optional and are used to expand primary functions.
Pump	The pump that is controlled with the aid of the application module. Each pump can be assigned to just one application module.

As soon as an application module is activated, it executes the corresponding primary and secondary functions in a cycle until it is deactivated.

All application modules can be executed in automatic and manual mode (↪ *section 3.2.10 "Automatic and manual mode" on page 38*).



- The parameters for the application modules are pre-configured by the manufacturer.
- Check that the parameters for the application modules are correct before commissioning for the first time.
- If there are problems with the configuration, contact customer service:
 - When doing so, provide the current configuration file
 - ↳ Section 7.2.1 “Backup and restore preparation” on page 250.
 - Or:
 - Have the pump controller’s order number and serial number at hand.
 - ↳ “Customer service” on page 8

5.3.1 Checking the assignments to application modules

The application modules are created by the manufacturer according to the customer’s specifications. The number of application modules and the corresponding primary functions and secondary functions depend on the pump controller configuration file that is used. Only the manufacturer can edit the configuration file. Therefore, check whether all required application modules, primary functions and secondary functions are present and assigned correctly before commissioning for the first time.

1. In “Configuration”, tap “Applications”.
 - ⇒ “Configuration – Applications” (Fig. 43) opens.

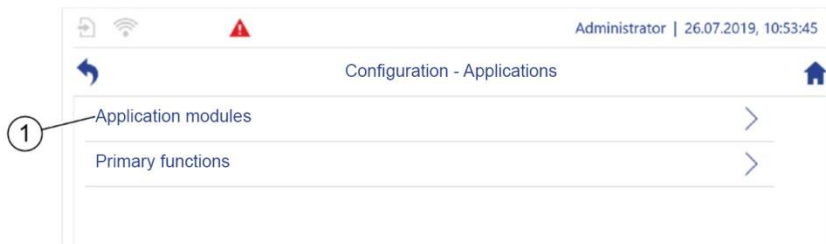

Configuration_applications-excerpt-01.png

Fig. 43: “Configuration – Applications”/“Configuration – Applications – Application modules”

2. Tap “Application modules” (Fig. 43/1).

⇒ “Configuration – Applications – Application modules” (Fig. 44) opens.

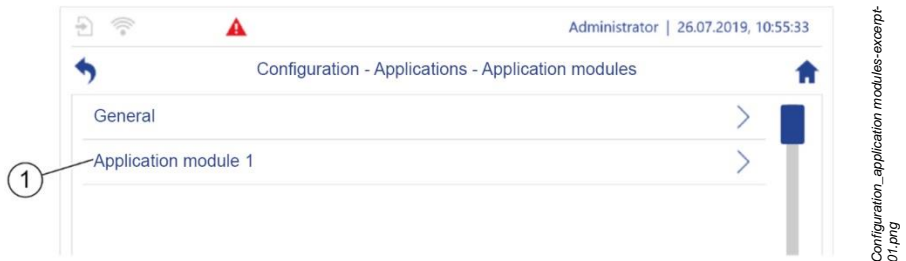

Fig. 44: “Configuration – Applications”/“Configuration – Applications – Application modules”

3. Tap “General” (Fig. 44/1).

⇒ “Configuration – Applications – Application modules – General” (Fig. 45) opens.

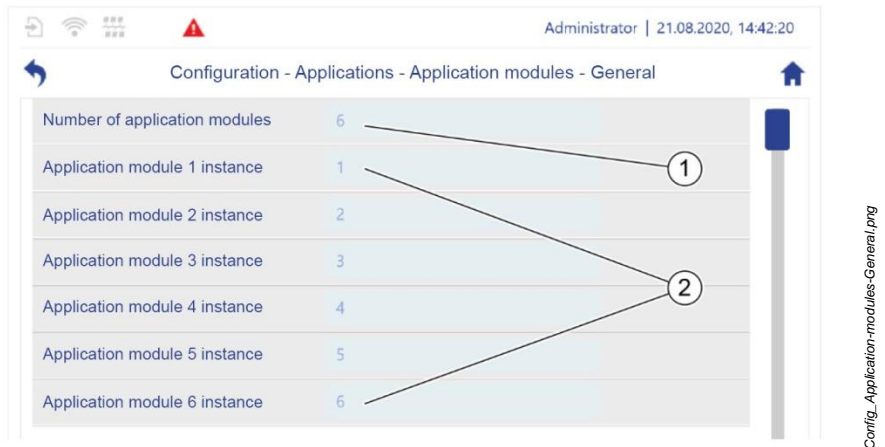

Fig. 45: “Configuration – Applications – Application modules – General”

⇒ The number of available application modules is displayed (Fig. 45/1).

⇒ The IDs of the available application modules are displayed. (Fig. 45/2).

4. Check whether the required application modules are present.

5. Tap the required application module (e.g. Application module 1).

⇒ “*Configuration – Applications – Application modules – Application module 1*” (Fig. 46) opens.

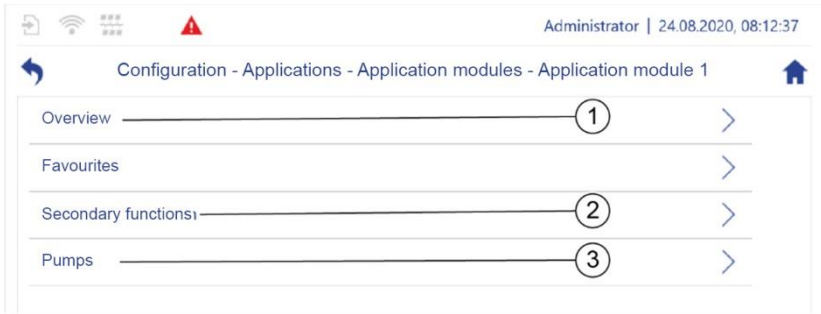

Configuration_Application-modules_Application-module.png

Fig. 46: “*Configuration – Applications – Application modules – Application module 1*”

6. Tap “*Overview*” (Fig. 46/1).

⇒ “*Configuration – Applications – Application modules – Application module 1 – Overview*” (Fig. 47) opens.

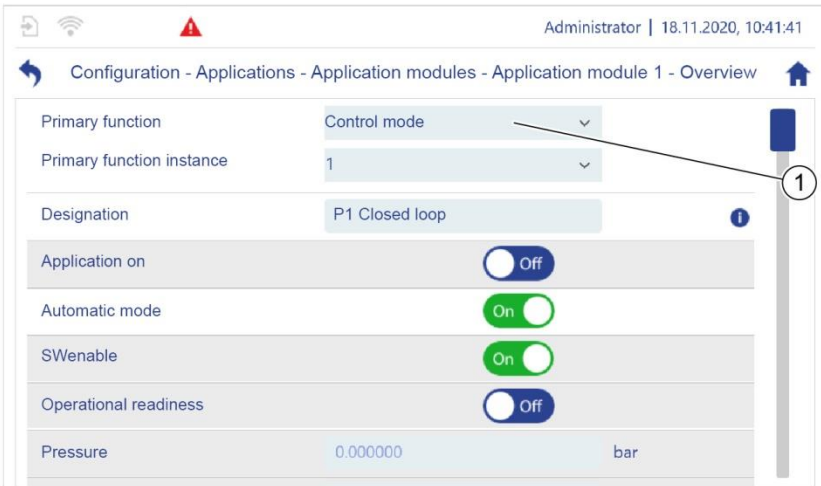

Configuration_Application-module1_Overview-01.png

Fig. 47: “*Configuration – Applications – Application modules – Application module 1 – Overview*”

7. Check whether the required primary function (Fig. 47/1) is assigned to the application module.

8. Navigate back to the menu for the required application module (e.g. Application module 1).
9. Tap “Secondary functions” (Fig. 46/2).
 - ⇒ “Configuration – Applications – Application modules – Application module 1 – Secondary functions” (Fig. 48) opens.

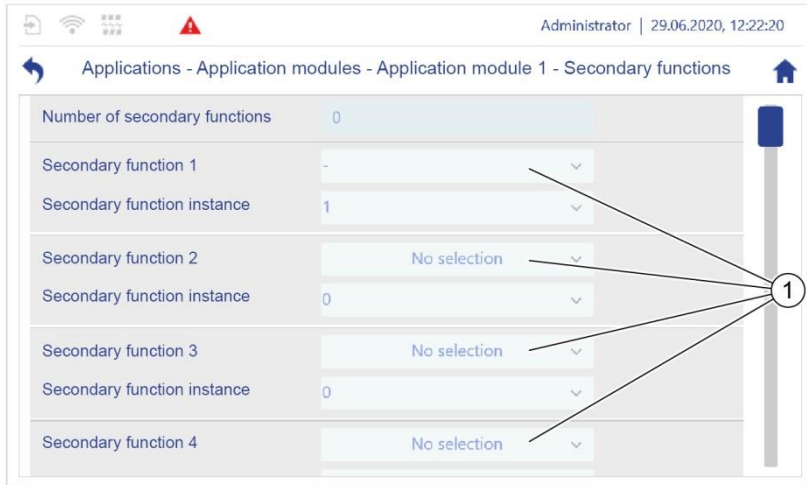

Configuration_Application-module1_Secondary-functions.png

Fig. 48: “Configuration – Applications – Application modules – Application module 1 – Secondary functions”

10. Check whether the required secondary function (Fig. 48/1) is assigned to the application module.
11. Navigate back to the menu for the required application module (e.g. Application module 1).
12. Tap “Pumps” (Fig. 46/2).
 - ⇒ “Configuration – Applications – Application modules – Application module 1 – Pumps” (Fig. 49) opens.

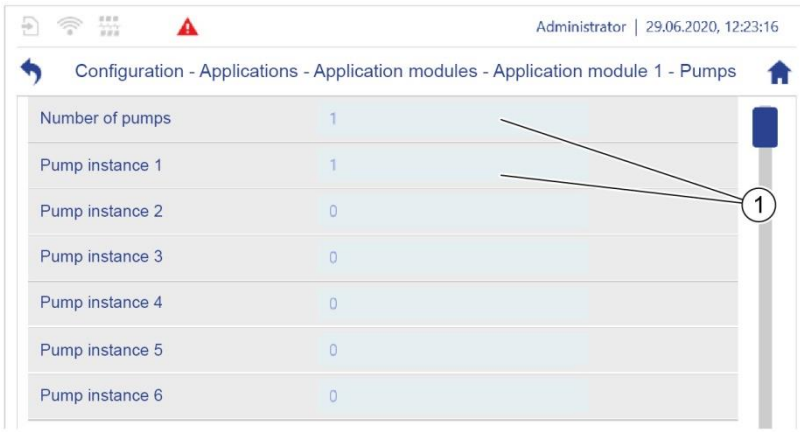

Configuration_Application-module1_Pumps.png

Fig. 49: "Configuration – Applications – Application modules – Application module 1 – Pumps"

13. Check whether the required pump (Fig. 49/1) is assigned to the application module.



Further information:

- [Section 5.4 "Primary functions" on page 100](#)
- [Section 5.5 "Secondary functions" on page 158](#)

5.3.2 Displaying parameters as favourites

You can display up to 8 parameters as favourites for each application module. Favourites enable up to 4 pump controller parameters to be displayed and changed in the application single view. In this way, you can display and monitor the values of the favourites at a glance during running operation.

You can display parameters as favourites at any time, even in running operation.

Only the following user groups can display favourites:

- Service
- Admin

1. In *“Configuration”*, tap *“Applications”*.
⇒ *“Configuration – Applications”* opens.
2. In *“Configuration– Applications”*, tap *“Application modules”*.
⇒ *“Configuration – Applications – Application modules”* opens.
3. Tap the application module for which favourites are to be displayed (e.g. Application module 1).
⇒ *“Configuration – Applications – Application modules – Application module 1”* opens.
4. Tap *“Favourites”*.
⇒ *“Configuration – Applications – Application modules – Application module 1 – Favourites”* (Fig. 50) opens.

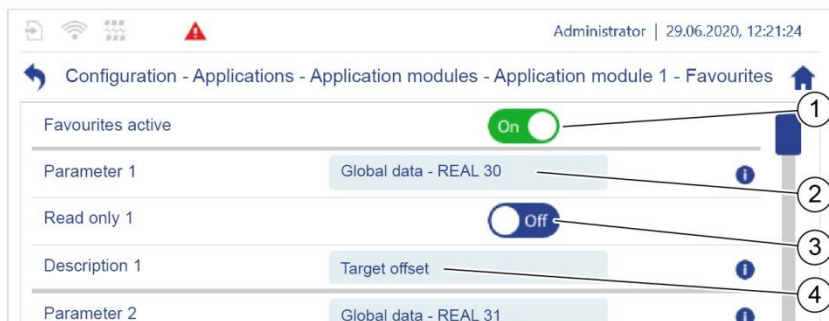

Configuration_Application-module_1_Favourites-01.png

Fig. 50: *“Configuration – Applications – Application modules – Application module 1 – Favourites”*

5. Activate the favourites display for this module. To do this, set the “Favourites active” software switch to *On* (Fig. 50/1).
6. Select the parameter that you wish to display as a favourite (Fig. 50/2).
7. If you do not want the favourite’s parameter value to be able to be changed in running operation in the application single view, you can set the “Read only” software switch to *On* (Fig. 50/3).
8. Assign an expressive description for the parameter (Fig. 50/4).
 - ⇒ The description is displayed in the application single view’s left or right display area as a tooltip above the favourite’s parameter value.

5.3.3 Switching the application module into manual mode

Each application module can be switched from automatic mode into manual mode. Manual mode is used to set up and test functions, and for troubleshooting. The effects of changed parameter values can be tested in manual mode.

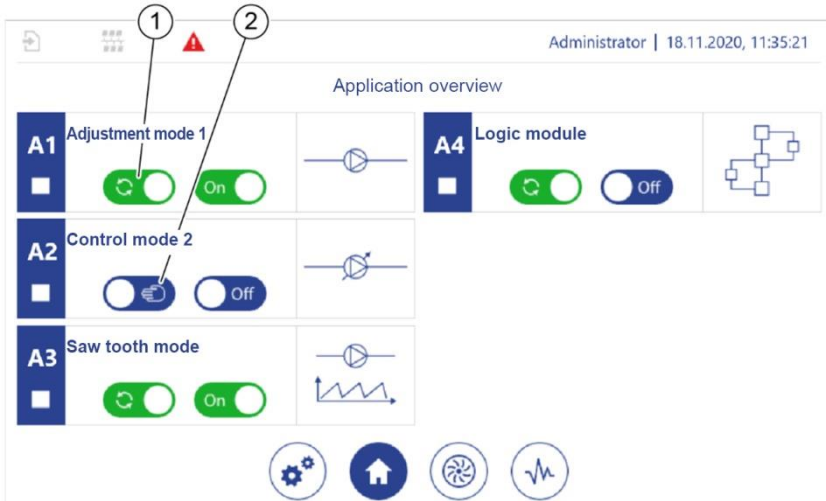

Application overview-01.png

Fig. 51: “Application overview”

- 1 Automatic mode
 - 2 Manual mode
1. In the “Application overview” (↪ section 5.7.3 ‘Using the application overview during operation’ on page 227), switch the required application module from automatic mode (Fig. 51/1) to manual mode (Fig. 51/2).
 - ⇒ As long as manual mode is activated for an application module, the higher-level controller does not receive a notification that it is ready for operation.
 2. In manual mode, check the effects of changed pump settings on the complete installation’s operation.



↪ Section 5.4.1 “Executing adjustment mode with one pump” on page 100 provides an example for using this function.

5.4 Primary functions

This section describes the possible primary functions.

The primary function defines the main function of the pumps connected to the application module, e.g. pressure regulation.

Primary functions can be expanded with secondary functions.

The primary functions that are available to you depend on the pump controller configuration file that is used. Only the manufacturer can edit the configuration file.



If there are problems with the configuration, contact customer service:

- To do this, provide the current configuration file
↳ *section 7.2.1 “Backup and restore preparation” on page 250.*

Or:

- Have the pump controller’s order number and serial number to hand.
↳ *“Customer service” on page 8*

5.4.1 Executing adjustment mode with one pump

In adjustment mode, constant frequency target values are specified for the frequency converter, which can be used to operate the pumps.

Prerequisites:

The corresponding application module is set up and selected:

- ↳ *Section 5.3.1 “Checking the assignments to application modules” on page 92*
 - ↳ *Section 5.7.3 “Using the application overview during operation” on page 227*
1. Check whether the required application module is set appropriately for the current task (e.g. to convey medium with a defined pressure or throughput).

Changing settings

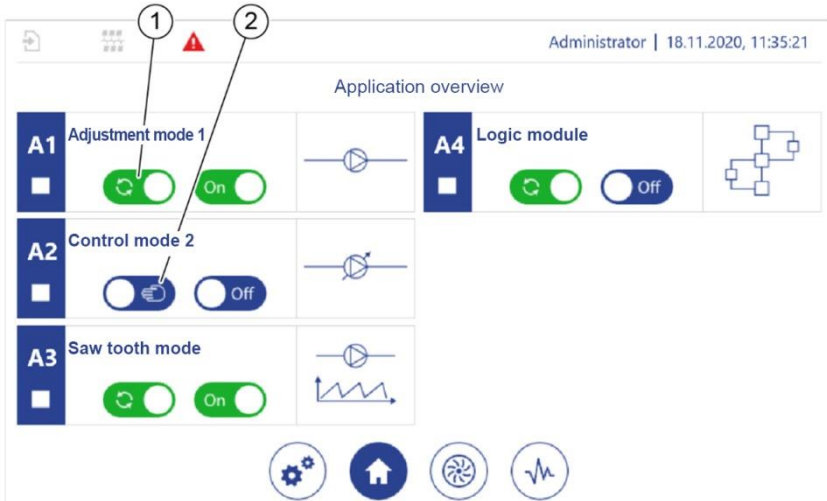
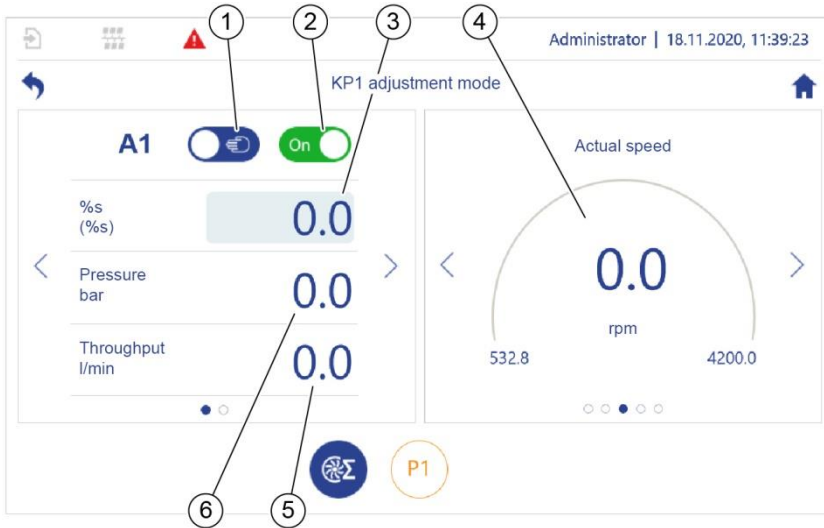

Fig. 52: “Application overview”

- 1 Automatic mode
 - 2 Manual mode
2. In the “Application overview” (↪ section 5.7.3 “Using the application overview during operation” on page 227), switch the required application module from automatic mode (Fig. 52/1) to manual mode (Fig. 52/2).
- Or:
- Switch the application module into manual mode in the application single view (Fig. 53).
- ⇒ As long as an application module is working in manual mode, the application module does not send an operational readiness signal to the higher-level controller.



Application-single-view_Frequency-adjustment-mode-01.png

Fig. 53: Specifying the pump speed

- 1 Manual/automatic mode
 - 2 Application on/off
 - 3 Enter target speed value
 - 4 Display actual speed value
 - 5 Resulting throughput
 - 6 Resulting pressure
3. In the “*Application overview*”, tap the required application module with the “Adjustment mode” primary function (↪ *section 5.7.3 ‘Using the application overview during operation’ on page 227*).
 - ⇒ The application single view opens (Fig. 53).
 4. Ensure that the pump is in manual mode (Fig. 53/1).
 5. Ensure that the pump is switched on (Fig. 53/2).
 6. Enter the changed speed (Fig. 53/3).
 7. Read the resulting process parameters (Fig. 53/5 + 6).
 8. If the required process parameters are not reached, re-adjust the target speed.
 9. Once adjustment is complete, exit manual mode (Fig. 52/2, Fig. 53/1).

5.4.2 Executing control mode with one pump

In control mode, process parameters are aligned continuously to an adjustable target value. Therefore, the pump controller continuously adjusts the pump's speed.

Prerequisites:

The corresponding application module is set up and selected:

- ↗ *Section 5.3.1 “Checking the assignments to application modules” on page 92*
- ↗ *Section 5.7.3 “Using the application overview during operation” on page 227*

1. In the “*Application overview*” (↗ *section 5.7.3 “Using the application overview during operation” on page 227*), tap the required application module.

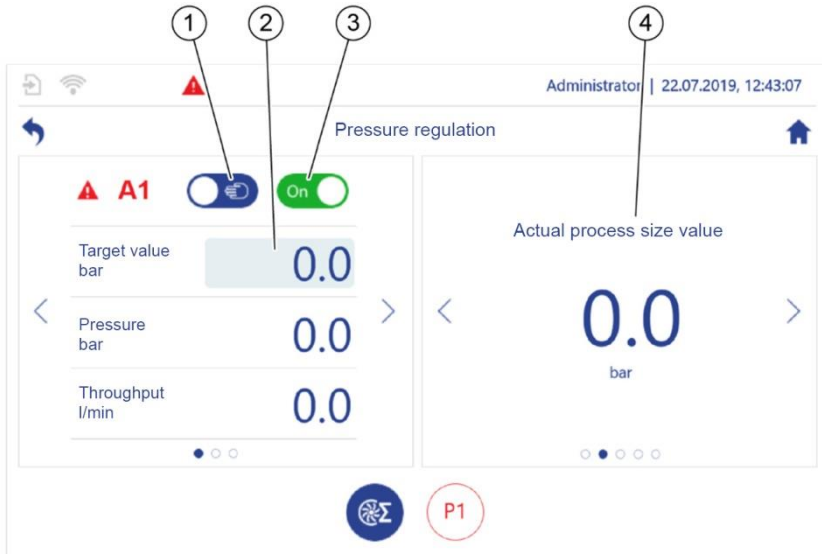

Application overview_pressure regulation-01.png

Fig. 54: Regulating the process value

2. Switch the application module into manual mode (Fig. 54/1).
3. Enter the target value for the required process size, e.g. the required pressure in bar if the pressure is to be regulated (Fig. 54/2).

4. Activate the application module (Fig. 54/3).
5. Read the process parameter's actual value (Fig. 54/4).
6. If the actual value does not reach the required target value quickly enough or oscillation is detected in regulation, use the “KP (P)”, “TN (I)” and “TV (D)” parameters in the application single view's left display area to re-adjust the PID controller.

Using fixed target values

Fixed target values are pre-set target values on the pump controller, from which the machine controller can select.

The fixed target values for the process parameters are pre-set for all application modules. You can call the fixed target values directly from the application single view's right display area (Fig. 55/1).

Fixed target values can only be entered in manual mode.

If the fixed target values are to be available after restarting the pump controller, you must save the fixed target values (↪ *section 7.2.4 “Backing up and updating settings” on page 257*).

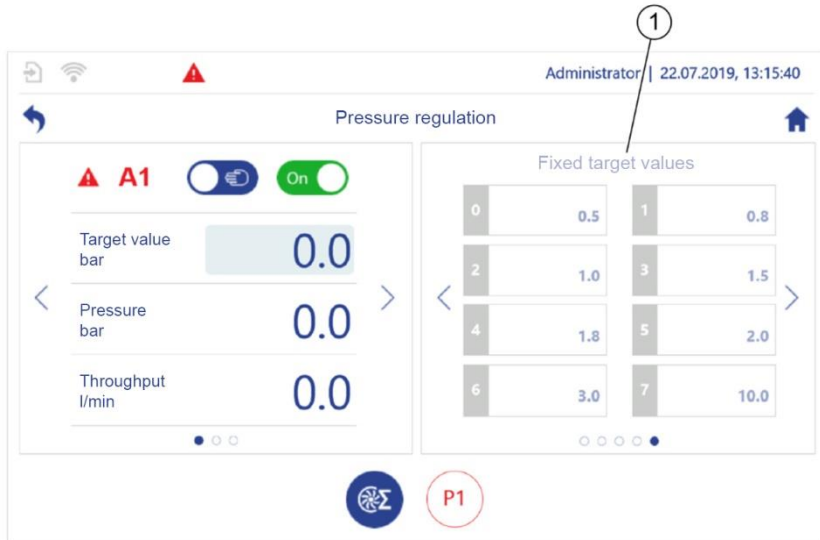

Application overview_pressure regulation_fixed target values-01.png

Fig. 55: Fixed target values

1. Switch the application module into manual mode.

2. Tap < or > until the fixed target value list is displayed in the application single view's right display area (Fig. 55/1).
3. Tap the required fixed target value.
4. Enter the required value.

5.4.3 Parallel mode

Parallel mode or group mode enables simultaneous control and regulation of up to 6 pumps that are all connected to a joint pipe system. In this way, a wide range of different flow rates can be provided. Furthermore, parallel mode can compensate for a failure of one pump by using a redundancy pump.

The pumps can be operated in various modes in parallel mode.

- Adjustment mode
- Control mode
- Cascade mode
- Operation as a redundancy pump
- Even mode

The operating modes are described in detail below.

5.4.3.1 Adjustment mode with one pump group

In adjustment mode with one pump group, the pump controller specifies the same target speed for each pump in the group.



The procedure is based on ↩ *section 5.4.1 "Executing adjustment mode with one pump" on page 100.*

Set the application module as described there.

5.4.3.2 Control mode with one pump group

In control mode with one pump group, all pumps in the group work at the same speed. The pump controller adjusts this speed continuously so that an adjustable target value, e.g. a required flow rate, is reached.



The procedure is based on ↪ *section 5.4.2 “Executing control mode with one pump” on page 103.*

Set the application module as described there.

5.4.3.3 Cascade mode with one pump group

In cascade more, the pumps are switched on and off in stages depending on pre-set speed thresholds.

If the upper speed threshold is exceeded, the pump controller switches another pump on to complete the conveyance task. If the lower speed threshold is not reached, the pump controller detects that it the flow rate with fewer pumps and switches a pump off.

The compensation task is taken on by all active pumps.

Setting speed thresholds

1. Tap the menu for the required primary function, “Parallel mode” in “*Configuration – Applications – Primary functions – Parallel mode*”, e.g. “*Parallel mode 1*”.
⇒ “*Configuration – Applications – Primary functions – Parallel mode 1*”. (Fig. 56) opens.



Fig. 56: “*Configuration – Applications – Primary functions – Parallel mode 1*”

2. Set a value for the lower speed threshold (Fig. 56/1).
3. Set a value for the upper speed threshold (Fig. 56/2).

5.4.3.4 Parallel mode with redundancy pumps

The pump controller can be used to configure a redundancy pump for adjustment mode or control mode for a pump group. This option must be pre-configured for the application module by the manufacturer.

The pump controller cannot be used to configure a redundancy pump for cascade mode. However, redundancy is possible if at least one more pump than required for the conveyance tasks is integrated into the system.

If a pump fails in parallel mode, a redundancy pump of the same type can take over the functions of the failed pump.

The pump that is used as the redundancy pump is not defined statically.

A redundancy pump is a role that every pump in a pump group gets cyclically assigned by the pump controller to be in stand-by mode. The pump in stand-by mode acts as spare pump.

As long as at least one of the pumps is functional, the application module remains active and attempts to complete the conveyance task.



The system owner must ensure that only pumps of the same type are used in parallel mode with redundancy pumps.

This is the only way to ensure that the pumps will provide the required performance.

5.4.3.5 Even mode with one pump group

You can set a pump group with a redundancy pump to even mode for adjustment mode and control mode.

In even mode, the pump controller starts up the last inactive pump after a freely-selectable operating period has elapsed and switches an active pump off at the same time.

You can set both the length of operating time after which this changeover occurs and the duration of the transition period during which the last inactive pump is started up and an active pump is shut down.

Using this cyclical pump changeover, even mode ensures that the operating time of all pumps in the pump group is the same and prevents long idle times, and therefore idle damage to the pumps.

Setting a forced changeover

1. Tap the menu for the required primary function, “Parallel mode” in “*Configuration – Applications – Primary functions – Parallel mode*”, e.g. “*Parallel mode 1*”.
 ⇒ “*Configuration – Applications – Primary functions – Parallel mode 1*”. (Fig. 57) opens.

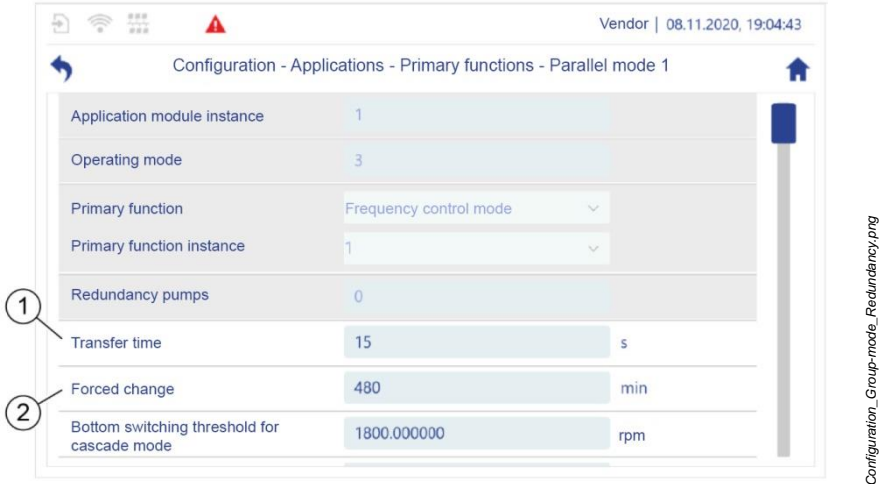

Fig. 57: “*Configuration – Applications – Primary functions – Parallel mode 1*”

2. Set the transition time (Fig. 57/1), during which an active pump is shut down and the last inactive pump is started up at the same time.
3. Set the operating time after which the cyclical changeover of the pumps is performed (Fig. 57/2).

5.4.4 Saw tooth cycle mode

Saw tooth cycle mode is used when pumping unfiltered lubrication back to a filtration system. In saw tooth cycle mode, a pump generates rinsing pulses by pumping a return tank empty in pulses. This keeps the medium moving in order to prevent deposits and blockages in the lines due to solids contained in the medium.

The return tank is monitored by fill level sensors during this process. Either one analog fill level sensor or two digital limit switches can be used to do this. As soon as the sensors report a sufficient fill level, the pump increases the speed and pumps the return tank empty to generate a rinsing pulse. As soon as the sensors report a low fill level in the return tank, the pump reduces the speed until the fill level increases again.

Saw tooth cycle mode can be set by the manufacturer on one of the following two modes:

Mode	Description
Manual	In manual mode, the application module specifies constant speeds for the pumps.
Automatic	You can specify a filling time in automatic mode. To reach this target value, the application module adjusts the speeds for filling the tank continuously.

Saw tooth cycle mode runs through 4 phases:

- Filling (Fig. 58/1)
- Boost (increased pump performance to prevent an overflow, Fig. 58/3)
- Emptying (Fig. 58/4)
- Sleep (reduced pump performance, Fig. 58/5)

Process sequence

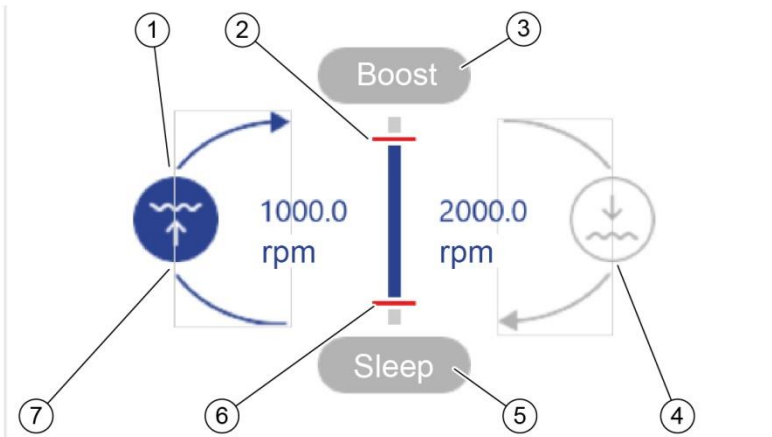

Saw-tooth-cycle-mode_sequence-01.png

Fig. 58: Saw tooth cycle mode sequence

- | | | |
|---|------------------|------------------------------------------------------------------------------------------------------------------------------------------|
| 1 | Filling | The return tank's fill level increases if the pump's speed is low. |
| 2 | Upper fill level | See "Boost" (Fig. 58/3) |
| 3 | Boost | When a defined upper fill level is exceeded, the pump switches to overload mode in order to prevent the return tank overflowing (boost). |
| 4 | Emptying | The return tank's fill level reduces while the pump pumps the return tank empty at a high speed |
| 5 | Sleep | When a defined lower fill level is not reached, the pump switches off (sleep). |
| 6 | Lower fill level | See "Sleep" (Fig. 58/5) |
| 7 | Active phase | The saw tooth cycle mode phase that is currently running is coloured blue in the application single view's right display area. |

You can also control the sequence of the phases using 3 timers for which parameters can be set:

- The “Boost activation” timer runs during the “Emptying” phase. If the pump’s performance is insufficient to lower the return tank’s fill level to below the upper fill level during the period set for the “Boost activation” timer, the pump controller sets the pump into the “Boost” phase. The pump then works with the speed set for the “Boost” phase instead of the speed set for the “Emptying” phase. This prevents the return tank from overflowing.
- The “Sleep activation” timer runs during the “Filling” phase. If the lower fill level of the return tank is not exceeded within the set time for the “Sleep activation” timer, the pump controller puts the pump into the “Sleep” phase. The pump then works with the speed set for the “Sleep” phase instead of the speed set for the “Filling” phase. This prevents the pump running dry.
- The “Overflow warning” timer runs during the “Boost” phase. You can use the “Overflow warning” timer to adjust how long the pump will run in the “Boost” phase before the pump controller sends a signal to the higher-level controller, e.g. to a machine tool. The pump controller uses the signal to inform the higher-level controller that the return tank could overflow.

You can define the following values for each phase in the application single view:

- The phase duration
- The elapsed times for the timers
- The pump’s speed

Using saw tooth cycle mode

Prerequisite:

The corresponding application module is set up and selected:

- ↪ *Section 5.3.1 “Checking the assignments to application modules” on page 92*
- ↪ *Section 5.7.3 “Using the application overview during operation” on page 227*

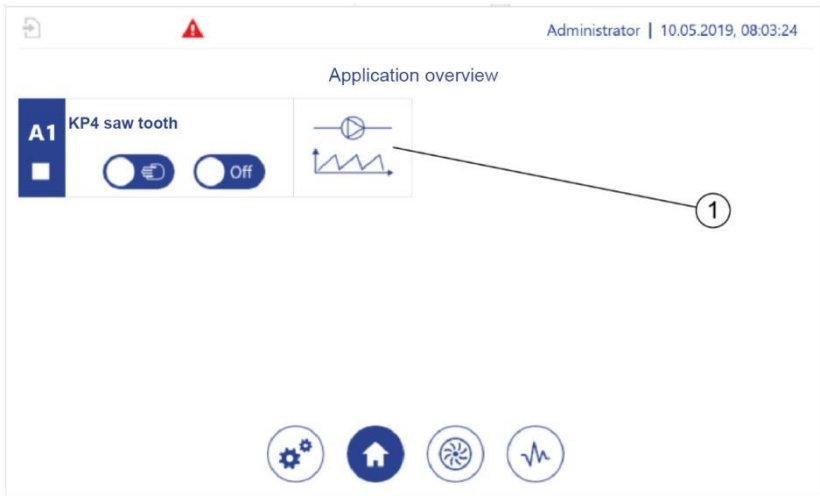

Application-overview_saw-tooth-mode.png

Fig. 59: Saw tooth cycle mode

1. In the “Application overview”, tap Saw tooth cycle mode (Fig. 59/1).
 ⇒ The application single view (A1 as an example here, Fig. 60) opens.

Filling

2. Tap < or > until the parameters for filling are displayed in the application single view’s left display area (Fig. 60/1).

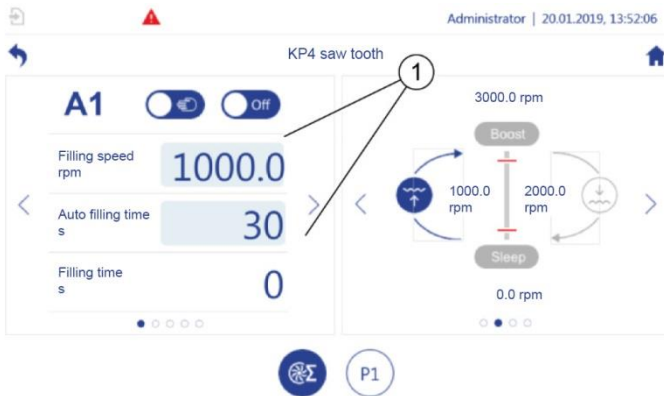

Applications_Saw-tooth-cycle-mode_Filling.png

Fig. 60: Saw tooth cycle mode – filling

3. Enter the required filling values (Fig. 60/1).

Boost

4. Tap < or > until the parameters for the boost phase are displayed in the left display area (Fig. 61/1).



Fig. 61: Saw tooth cycle mode – boost

5. Enter the values for the boost phase (Fig. 61/1).

Emptying

6. Tap < or > until the parameters for emptying are displayed in the left display area (Fig. 62/1).

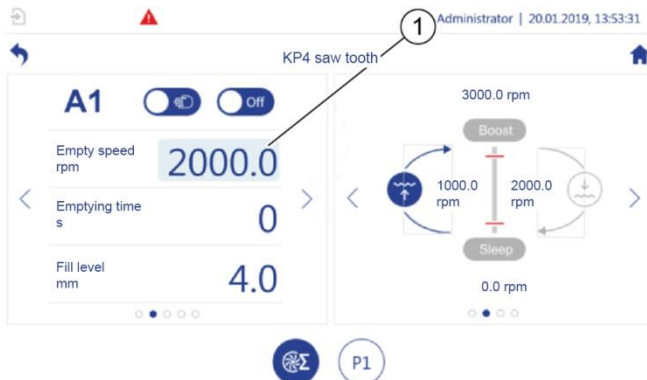
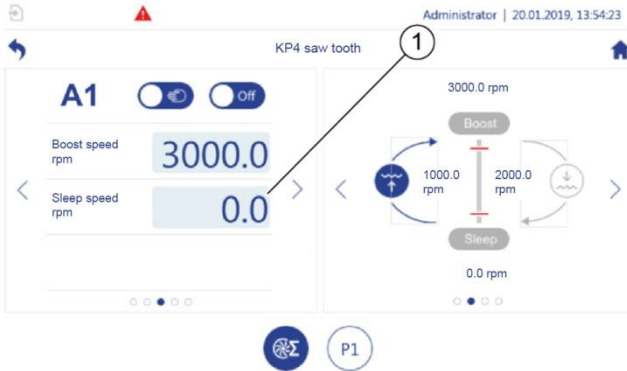

Fig. 62: Saw tooth cycle mode – emptying

7. Enter the values for emptying (Fig. 62/1).

Sleep

8. Tap < or > until the parameters for the sleep phase are displayed in the left display area (Fig. 63).



Applications_Saw-tooth-cycle-mode_Sleep.png

Fig. 63: Saw tooth cycle mode – sleep

9. Enter the values for the sleep phase (Fig. 63/1).

Setting timer parameters

10. Tap < or > until the parameters for the timer functions are displayed in the left display area (Fig. 64).



Applications_Saw-tooth-cycle-mode_Timer.png

Fig. 64: Saw tooth cycle mode – timer

11. Set the required duration for the “Boost activation” timer (Fig. 64/1).
12. Set the required duration for the “Sleep activation” timer (Fig. 64/2).

13. Set the required duration for the “Overflow warning” timer (Fig. 64/3).

Offset



To use the offset function, see ↗ *section 5.5.1 “Offset control” on page 158.*

5.4.5 Pressure increase

During the pressure increase, two pumps are used in series. The first pump generates the pre-pressure. The second pump regulates the pressure generated to an adjustable target value (final pressure).

You can define a fixed target value for the speed of one of the pumps. The pump controller adjusts the other pump’s speeds continuously until the required final pressure is reached.

Prerequisites:

The corresponding application module is set up and selected:

- ↗ *Section 5.3.1 “Checking the assignments to application modules” on page 92*
- ↗ *Section 5.7.3 “Using the application overview during operation” on page 227*

1. In the “*Application overview*” (↗ *section 5.7.3 “Using the application overview during operation” on page 227*), tap the required application module with the “Pressure increase” primary function.
2. Call the pump single view for the pump with a fixed speed.

Pump with fixed speed

3. Specify the required frequency ↗ *section 5.4.3.1 “Adjustment mode with one pump group” on page 105.*
4. Call the pump single view for the regulated pump.

Regulated pump



Applications_Pressure-increase-01.png

Fig. 65: Pressure increase

5. Enter the required target value for the final pressure (Fig. 65/1).

Both pumps

6. If the required pressure is not reached within the required time, use the “KP (P)”, “TN (I)” and “TV (D)” parameters in the application single view’s left display area to re-adjust the PID controller.



Also adjust the fixed speed for the first pump in order to re-adjust. You can check the effect of changed pump settings on the pressure generated in manual mode.

↳ Section 5.4.3.1 “Adjustment mode with one pump group” on page 105.

5.4.6 Logic module

You can use the logic modules to expand the conveyance functions in the other application modules with their own functions and switching tasks. The logic module can perform functions that would otherwise have to be performed by a separate PLC.

The logic module can access all parameters contained in the parameter list, including the parameters for the other application modules. For example, a function whose parameters were set by the logic module can activate a different application module, change a pump's speed, or open and close a valve during operation.

The logic module controls functions using its own actions. Some actions are merged into action blocks. You can configure a total of 6 action blocks with 20 actions each.

An action block cannot be used several times. This means that if you assign all 6 possible action blocks to the same logic module, you cannot assign any action blocks to any other logic module.

Each action can execute one of 10 possible commands.

All commands with the exception of the "Generate event" command can trigger an event message in addition to their other functions. The user defines the content of this event message.

Command	Description
Copy	<p>The command copies and writes the values from up to 6 source parameters to a corresponding number of target parameters.</p> <p>Example:</p> <p>When an application module is activated, the "Copy" command can be used to copy the parameter value that displays operational readiness of the application module and to write this to the readiness parameters for other application modules. In this way, several application modules can be activated automatically and simultaneously.</p>

Command	Description
Write	<p>The command writes up to 6 freely-selectable values to a corresponding number of target parameters.</p> <p>Example: You can use the “Write” command to define a pressure value as the target value for several applications at the same time.</p>
Generate event	<p>The command triggers an event message. You define the content of this event message.</p> <p>Example: If a process size exceeds a specified value, the “Generate event” command triggers a warning message.</p>
Go to action	<p>The command defines which action follows the current action.</p> <p>Example: You can use the “Go to action” command to skip or repeat actions.</p>
Add	<p>The command adds up to 6 freely-selectable values or the parameter values from up to 6 parameters in the parameter list to the values for the corresponding target parameters.</p>
Subtract	<p>The command subtracts up to 6 freely-selectable values or the parameter values from up to 6 parameters in the parameter list from the values for the corresponding target parameters.</p>
Multiply	<p>The command multiplies up to 6 freely-selectable values or the parameter values from up to 6 parameters in the parameter list by the values for the corresponding target parameters.</p>

Command	Description
Divide	The command divides the value of the corresponding target parameters by up to 6 freely-selectable values or by the parameter values from up to 6 parameters in the parameter list.
Reset lead time timer	<ul style="list-style-type: none">• The command stops the expiration of the lead time timer for up to 6 different actions.• The command resets the timer for the stopped lead time.
Reset follow-up time timer	<ul style="list-style-type: none">• The command stops the expiration of the follow-up timer for up to 6 different actions.• The command resets the timer for the stopped follow-up time.

The following terms apply to this:

	Description
Source parameters	<p>Source parameters are used as the source for the “Copy” command or as comparison values.</p> <p>You can select up to 6 source parameters for each action. All parameters in the parameter list and all of the logic module’s markers can be source parameters.</p>
Target parameters	<p>Target parameters are processed by the “Write”, “Copy”, “Add”, “Subtract”, “Multiply” and “Divide” commands. The value of a target parameter is the result of an action.</p> <p>You can select up to 6 target parameters for each action. All parameters in the parameter list and all of the logic module’s markers can be target parameters.</p>

	Description
Markers	<p>Markers are global data. Logic module actions can save intermediate results in markers and read them in again. Depending on the format of the intermediate results, markers are available in the data types BOOL, UDINT and REAL. Markers help when coupling actions if an upstream action performs pre-processing for a subsequent function.</p> <p>Example:</p> <p>Action 1 checks whether there is a start signal on PIN 1 and whether the pressure is > 10 bar. If the condition that it checks is true, action 1 writes the value "1" = "true" on marker 1.</p> <p>Action 2 is configured so that it checks marker 1 and switches the pump off if marker 1 has the value "1".</p> <p>In this way, the result of an action can trigger or prevent execution of a further action automatically.</p>
Lead time	<p>A lead time timer can be set for each action. The lead time is used to delay execution of a command. The command is only executed if a specific condition is met over the entire duration of the lead time.</p>
Follow-up time	<p>A follow-up time timer can be set for some actions. The follow-up time is used to delay execution of a command. The command is only executed if a specific condition is not met over the entire duration of the follow-up time.</p>

5.4.6.1 Planning the logic module

Parameters are set for the logic module's actions in the same way as for logic functions and follow an IF-THEN-ELSE structure (Fig. 66). This structure enables you to assign a condition to a command, which must be met for the command to be executed.



The explanation of the logic functions should enable you to plan a logic module and to set the parameters as logic functions for all actions that are required to operate your system.

If you require further support when setting parameters for actions, contact the pump controller’s manufacturer.



A total of 6 application modules can be configured for the pump controller. If the “Logic module” primary function is assigned to all 6 application modules, there is no application module available on the pump controller to control conveyance tasks.

- Ensure that enough application modules are configured to control the conveyance tasks in addition to the required logic modules.
- For the individual configuration of your pump controller, refer to the “Data for setting the blogic parameters” questionnaire.

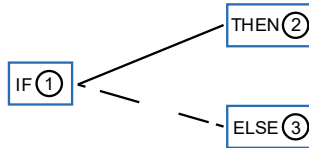

IF-THEN-ELSE-01.svg

Fig. 66: Layout of a logic function

Fig. 66 shows the basic elements in a logic function. The logic function comprises a condition (Fig. 66/1) and a branch. Depending on whether the condition is met or not, another command branch (Fig. 66/2 and 3) will run.

The following terms apply to this:

	Description
IF command (Fig. 66/1)	An IF command must be defined for each action. The IF command uses a comparison to check whether the condition defined for executing a command is true (= the condition is met) or false (= the condition is not met).

	Description
THEN command (Fig. 66/2)	<p>A THEN command must be defined for each action. If the condition checked by the IF command is true, the THEN command is executed.</p> <p>The THEN command triggers one of the ten commands: “Copy”, “Write”, “Generate event”, “Go to action”, “Add”, “Subtract”, “Multiply”, “Divide”, “Reset lead time timer” and “Reset follow-up time timer”. You can select which command is executed for each action.</p>
ELSE command (Fig. 66/3, optional)	<p>An ELSE command can be defined for each action.</p> <ul style="list-style-type: none">• If the condition checked by the IF command is false and an ELSE command is defined, the ELSE command is executed.• If the condition checked by the IF command is false and no ELSE command is defined, no command is executed. <p>The ELSE command triggers one of the ten commands: “Copy”, “Write”, “Generate event”, “Go to action”, “Add”, “Subtract”, “Multiply”, “Divide”, “Reset lead time timer” and “Reset follow-up time timer”. You can select which command is executed for each action.</p>

Example of a logic function:

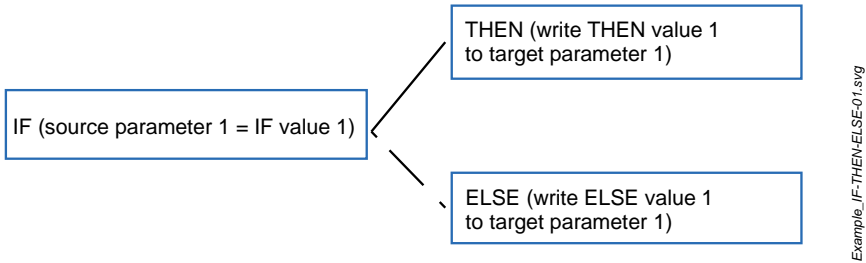

Fig. 67: Example of a logic function

In this example (Fig. 67), the IF command uses a comparison to check whether the value of a source parameter corresponds to the value of a comparison variable (IF value 1).

If the two values compared are the same, the condition is true. In this case, the THEN command is used to write a command variable (THEN value 1) to a target parameter. This THEN value 1 can cause a valve to be opened for example.

If the two values compared are the not same, the condition is false. In this case, the ELSE command is used to write a different command variable (ELSE value 1) to the target parameter.

The following terms apply to this:

	Description
IF value	<p>The IF value is a comparison value. The IF command compares the IF value to a source parameter in order to check a condition. You can define up to six different IF values for each action.</p> <p>Each action can compare up to 6 different source parameters with up to 6 IF values. The number of IF values must correspond to the number of source parameters.</p>

	Description
THEN value	<p>The THEN value is a value that the THEN command uses to edit the target parameter if the condition defined for executing a command is true.</p> <p>The way in which the THEN command edits the THEN value and the target parameter depends on the command that was executed. If the “Write” command is executed as in the example, the THEN command writes the THEN value to the target parameter. You can define up to 6 different THEN values for each action. Each command can edit up to 6 target parameters with up to 6 different THEN values. The number of THEN values must correspond to the number of target parameters.</p>
ELSE value	<p>The ELSE value is a value that the ELSE command uses to edit the target parameter if the condition defined for executing a command is false.</p> <p>The way in which the ELSE command edits the ELSE value and the target parameter depends on the command that was executed. If the “Write” command is executed as in the example, the ELSE command writes the ELSE value to the target parameter. You can define up to 6 different ELSE values for each action. Each command for which the ELSE command is defined can edit up to 6 different target parameters with up to 6 different ELSE values. The number of ELSE values must correspond to the number of target parameters.</p>
Comparison variable	<p>A comparison variable is a value that is set as the IF value for an action.</p> <p>You can define the following values as the comparison variable:</p> <ul style="list-style-type: none"> • A free value that you entered • Any parameter from the parameter list • A marker

	Description
Command variable	<p>A command variable is a value that is set as the THEN value or ELSE value for an action.</p> <p>You can define the following values as the command variable:</p> <ul style="list-style-type: none">• A free value that you entered• Any parameter from the parameter list• A marker

Conditions

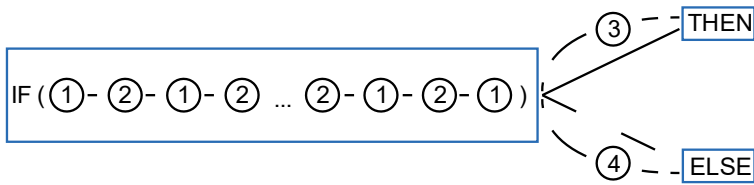

Condition_principle_01.svg

Fig. 68: Layout of a condition

Fig. 68 shows the elements that are required to define the condition for executing a command.

	Description
Comparison (Fig. 68/1)	<p>The comparison is the basis of a condition. In order to check a condition, the IF command compares the value of a source parameter using an operator with an If value.</p> <p>One of six possible operators can be used in each comparison:</p> <ul style="list-style-type: none"> • equal (=): The condition is true if the source parameter is equal to the IF value. • not equal (< >): The condition is true if the source parameter is not equal to the IF value. • greater than (>): The condition is true if the source parameter is greater than the IF value. • greater than or equal to (> =): The condition is true if the source parameter is greater than or equal to the IF value. • less than (<): The condition is true if the source parameter is less than the IF value. • less than or equal to (< =): The condition is true if the source parameter is less than or equal to the IF value. • no branching: If you select “no branching”, the condition is not checked and the THEN command is executed.

	Description
<p>Link (Fig. 68/2)</p>	<p>A link is used to add further comparisons to the IF command. The following two links can be used:</p> <ul style="list-style-type: none"> • AND: The THEN command is only executed if all of the comparisons linked to the AND link are true. • OR: If one or several of the comparisons linked to the OR link are true, the THEN command is executed. <p>Each IF command can contain only AND links or only OR links. Each IF command can contain up to 5 links. Therefore, up to 6 comparisons can be linked for each action.</p> <p>All comparisons in an IF command must contain the same operator types. This means that an IF command can contain 4 comparisons with the greater than operator (>) but not 2 comparisons with the greater than operator (>) and 2 comparisons with the less than or equal to (<=) operator.</p> <p>A source parameter and an IF value must be specified for each of the up to 6 comparisons.</p> <p>Example: A possible condition is, for example: IF (source parameter 1 > IF value 1 AND source parameter 2 > IF value 2). In this example, two comparisons are linked with AND. This means that the THEN command is only executed if both comparisons are true. Source parameter 1 must therefore be greater than IF value 1 and source parameter 2 greater than IF value 2.</p> <p>The same value can be defined for both IF value 1 and IF value 2, e.g. "0".</p>
<p>Lead time (Fig. 68/3)</p>	<p>An optional lead time timer can be set for each action. The lead time duration can be set individually for each action.</p> <p>The lead time is used to delay a THEN command. The THEN command is only executed at the end of the lead time if the condition is true for the entire duration of the lead time. This way, changes to a parameter value during the lead time, e.g. due to pressure peaks, can prevent the command being executed.</p>

	Description
Follow-up time (Fig. 68/4)	<p>An optional follow-up time can be set for each action for which an ELSE function is defined. The follow-up time duration can be set individually for each action.</p> <p>The follow-up time is used to delay an ELSE command. If the condition is false, the ELSE command is executed at the end of the follow-up time.</p>

Example of a logic function with a lead and run-on time:

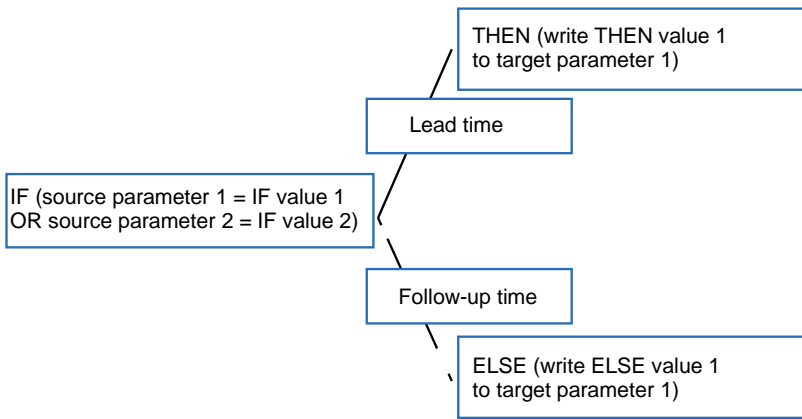

Example2_IF-THEN-ELSE-01.srg

Fig. 69: Example of a logic function with a lead and follow-up time

In this example (Fig. 69), the IF command compares two source parameters with two IF values. As the two conditions are linked with an OR link, only one of the two comparisons must be met for the condition to be considered true.

If the condition is true, the THEN command is executed and THEN value 1 is written to target parameter 1. However, a lead time precedes the THEN command in this example. This means that the THEN command will only be executed if the condition is true for the entire duration of the lead time.

If the condition is false, the ELSE command is executed. A follow-up time precedes the ELSE command in this example. This means that the required ELSE command is only executed at the end of the run-on time. In this case, ELSE value 1 is written to target parameter 1 at the end of the run-on time.

5.4.6.2 User-defined event messages

Event messages are generated if a valid event ID is defined for an action and the IF command runs.

All commands can trigger event messages.

You can define the contents and properties of these event messages yourself:

- The type of event message (Fig. 70/4):
 - Error message
 - Warning message
 - Information
- The error code (Fig. 70/3)
- The error description (Fig. 70/1)
- The instructions for error correction (Fig. 70/2)

You can create the error description text and the instructions for error correction freely. The texts are stored in the following text lists:

- “tl_customereventdescription.txt”: contains the error description text
- “tl_customereventtroubleshooting.txt”: contains the error correction text

You can update both text lists at any time.



For information regarding the pump controller's event messages, also see [↗ section 7.3 “Event messages” on page 260.](#)

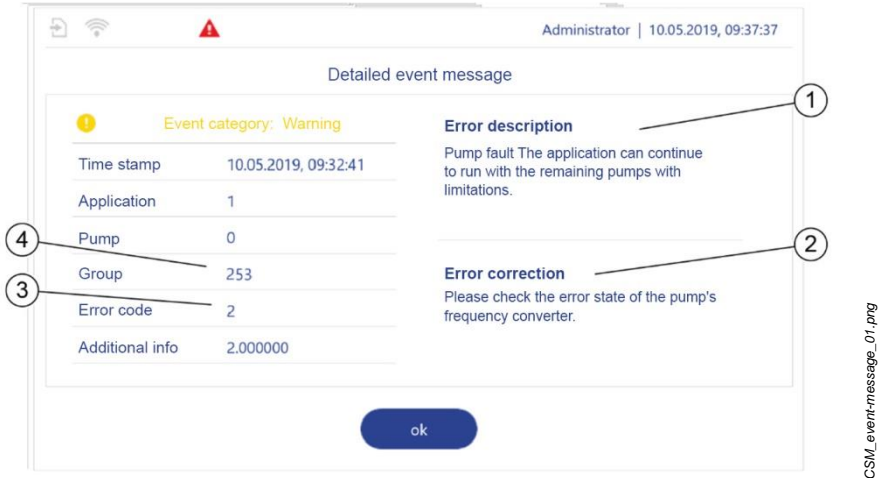

Fig. 70: Layout of an event message

- | | | |
|---|-------------------|-----------------------------------------------------------------------------------------------------------------------------------------------------------------------------------------------------------------------------------------------------------------------------------------------------------------------------------------------------------------------------|
| 1 | Error description | Specifies the cause and consequences of a fault |
| 2 | Error correction | Describes the error rectification methods |
| 3 | Error code | <ul style="list-style-type: none"> • This must be between 1 and 10 for information or a warning message • This must be between 1 and 20 for an error message <p>You can only assign each error code for each message type once. This means that you can create a maximum of 20 error messages, 10 warning messages and 10 information messages.</p> |
| 4 | Group number | <p>Defines the type of event message:</p> <ul style="list-style-type: none"> • 252: Information • 253: Warning message • 254: Error message |

Event ID

Each event message has a six-character event ID. This event ID is used to:

- Identify the event message uniquely
- Assign texts for the error description and error correction to the event message
- Assign the event message to a logic module action

Each valid event ID apart from event ID 000000 generates an event message. Event ID 000000 does not generate an event message. This event ID is used when setting parameters for actions that are not to trigger an event message.

For user-defined event messages, you must compose the event ID of the group number and the error code.

- The group number specifies the first three numbers of the event ID.
- The error code specifies the last three numbers of the event ID. You must add leading zeros to the error code.

Example:

The warning message contained in Fig. 70 has group number “253” and error code “2”. The complete event ID for the warning message is therefore “253002”.

Flags

You can also set a flag for each action. The flag is used as a status indicator: If a flag is set for an event message, this event message remains active until it is acknowledged (Fig. 71).

If an active event message is present, the “Event list” button is displayed in the status bar for each menu. Active event messages are also marked as active in the “*Event list*” menu.

Administrator | 12.11.2019, 09:52:09

Detailed event message

Event category: Error		Error description
Time stamp	12.11.2019, 09:49:08	HW enable for FC6 not set, operational readiness withdrawn
Application	2	
Pump	0	Error correction Please check the release for FC 6 on the Brinkmann controller using KC12
Group	254	
Error code	6	
Additional info	1.000000	Error description

CSM_Error-message_Flag-01.png

Fig. 71: Event message with flag

Event messages for which no flag is set do not have to be acknowledged (Fig. 70). As soon as the cause of the event message has been rectified, these event messages are closed automatically and marked as inactive in the “Event list” menu.

Example:

The system displays an error message because it detects a cable break. If no flag is set for this error message, the event message is closed automatically as soon as the system reports that the cable break has been rectified.

If a flag is set for the error message, the event message is displayed until it is acknowledged even if the cable break has already been rectified.

5.4.6.3 Creating and saving user-defined event messages

You can create, edit and save message texts in the text lists “tl_customereventdescription.txt” and “tl_customereventtroubleshooting.txt”. To do this, you must export the pump controller’s text lists to a PC and use an external text editor to edit them. You must then re-import the text lists. Only the following user groups can use the “Import/export text lists” menu that is required:

- Service

- Admin



One of the following two operations is required to export and import the text lists:

- Link the pump controller to a PC:
 - ↪ *Section 5.6.3 “Setting LAN parameters” on page 202.*
 - ↪ *Section 5.6.4 “Setting WLAN module parameters” on page 205*
- Connect a storage medium to the pump controller:
 - ↪ *Section 5.6.7.2 “Connecting storage media” on page 222*

Exporting text lists

1. Ensure that you are logged in to the pump controller with one of the following user groups:
 - Service
 - Admin
2. Tap  in the navigation bar.
⇒ The “*Configuration*” menu opens.
3. In the “*Configuration*” menu, tap “*Applications*”.
⇒ “*Configuration – Applications*” opens.
4. In “*Applications*”, tap “*Primary functions*”.
⇒ “*Configuration – Applications – Primary functions*” (Fig. 76) opens.

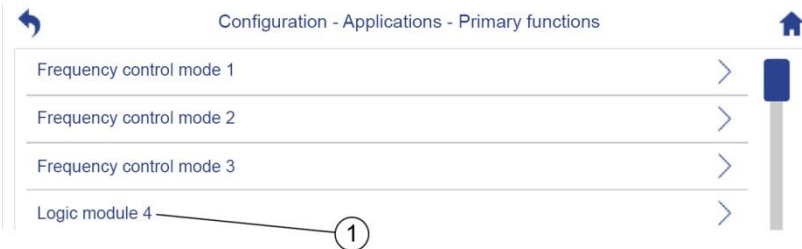

Config_Application_Logic-module.png

Fig. 72: “*Primary functions*”

5. Tap the required logic module, e.g. “*Logic module 4*” (Fig. 72/1)

⇒ The configuration menu for the logic module (Fig. 73) opens.

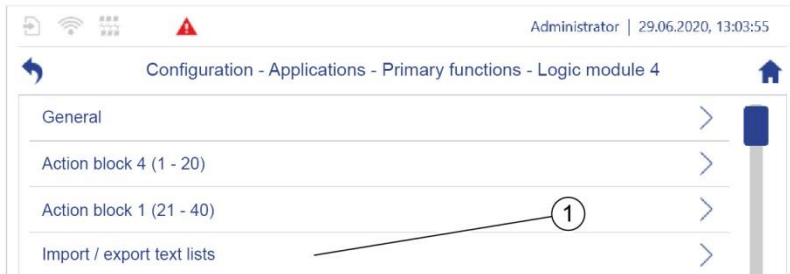

Config_Logic-function1-01.png

Fig. 73: “Logic module 4”

6. Tap “Import/export text lists” (Fig. 73/1).

⇒ “Configuration – Applications – Primary functions/Logic module 1/Import/export text lists” (Fig. 74) opens.

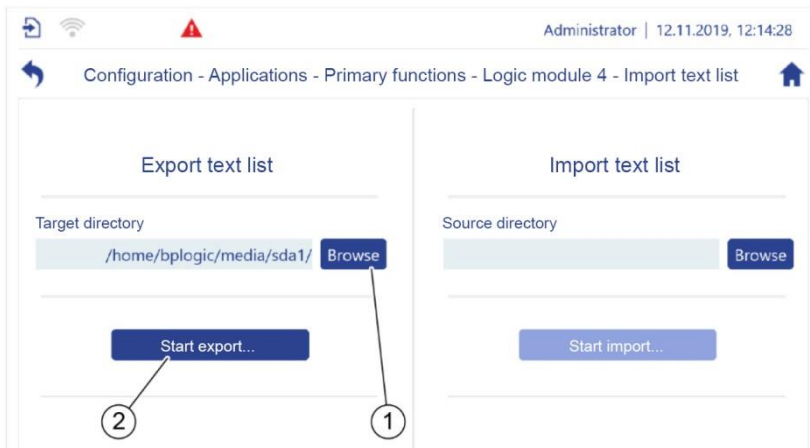

Export_text-lists-01.png

Fig. 74: “Import/export text lists”

7. Tap the “Browse” button (Fig. 74/1) to select a target directory:

- If the pump controller is linked to a PC, specify one of the pump controller’s directories as the target directory.
- If the pump controller is not linked to a PC: Connect a storage medium to the pump controller and specify a path on the storage medium as the target directory.

8. Tap the “Start export...” button (Fig. 74/2).

- ⇒ The text lists “tl_customereventdescription.txt” and “tl_customereventtroubleshooting.txt” are copied to the target directory.
 - ⇒ The “Text lists exported successfully” message confirms that the text lists were exported successfully.
9. If the pump controller is linked to a PC, use remote access to copy the text lists from the target directory to a directory on the PC.

Editing text lists

1. Open the text list “tl_customereventdescription.txt” in a text editor.
2. Create the text for the error description.
3. Store the event ID together with the error description in the text list.
4. Save the edited text list on the PC or the storage medium.
5. Open the text list “tl_customereventtroubleshooting.txt” in a text editor.
6. Adjust the error correction text as required.
7. Store the event ID together with the error correction text in the text list “tl_customereventtroubleshooting.txt”.
8. Save the edited text list on the PC or the storage medium.

Importing text lists

1. Connect the pump controller to the PC or connect the storage medium on which the edited text lists are saved.
2. If the pump controller is linked to a PC, use remote access to save the text lists to a directory on the pump controller.
3. Open the “*Import/export text lists*” menu for the required logic module (Fig. 75).

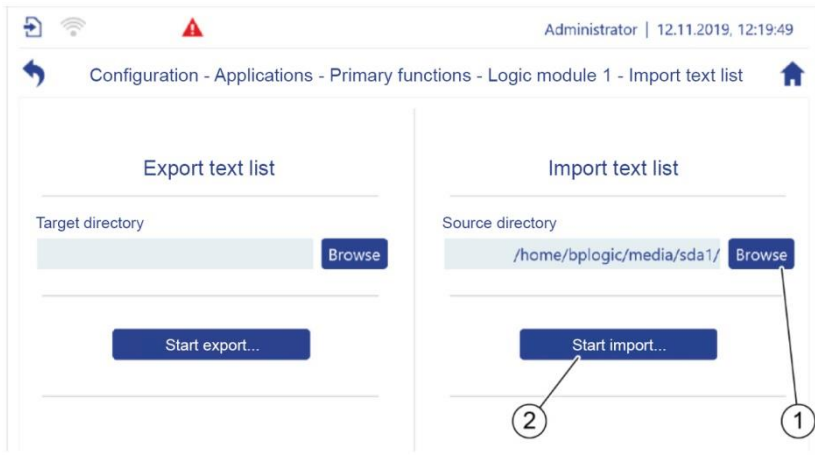

Import_text_lists-01.png

Fig. 75: "Import/export text lists"

4. In "Import/export text lists", tap the "Browse" button.
5. Specify the source directory in which the edited text lists are saved.
6. Tap the "Start import..." button.
 - ⇒ A message confirms that the text lists were imported successfully and requests that you restart the pump controller.
7. Restart the pump controller (↪ section 5.6.2.7 "Device restart" on page 201).
 - ⇒ The new user-defined event message is stored in the system and can be assigned to an action (↪ "Setting logic module parameters and checking" on page 137).

5.4.6.4 Setting logic module parameters and checking

This section enables you to:

- Plan a logic module and set the parameters for the required actions as logic functions
- Check that the parameters set are correct

You can view the logic module's parameters and its actions at any time, and check that they are correct.

You can only set parameters for the logic module and its actions as long as the logic module is deactivated.

All user groups can view the logic module's parameters and its actions, and check that they are correct.

Only the following user groups can set parameters for the logic module and its actions:

- Service
- Admin



- Check that the parameters set for the logic module are correct before commissioning for the first time.
- If there are problems with the configuration, contact customer service:
 - When doing so, provide the current configuration file
↳ *Section 7.2.1 “Backup and restore preparation” on page 250.*
 - Or:
 - Have the pump controller's order number and serial number to hand.
↳ *“Customer service” on page 8*

1. Tap  in the navigation bar.
⇒ The “*Configuration*” menu opens.
2. In the “*Configuration*” menu, tap “*Applications*”.
⇒ “*Configuration – Applications*” opens.
3. In “*Applications*”, tap “*Primary functions*”.
⇒ The “*Configuration – Applications – Primary functions*” (Fig. 76) view opens.

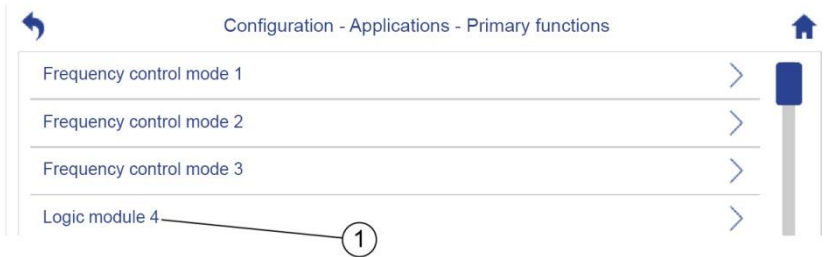

Config_Application_Logic-module.png

Fig. 76: “*Primary functions*”

4. Tap the required logic module, e.g. “*Logic module 4*” (Fig. 76/1)

⇒ The configuration menu for the logic module (Fig. 77) opens.

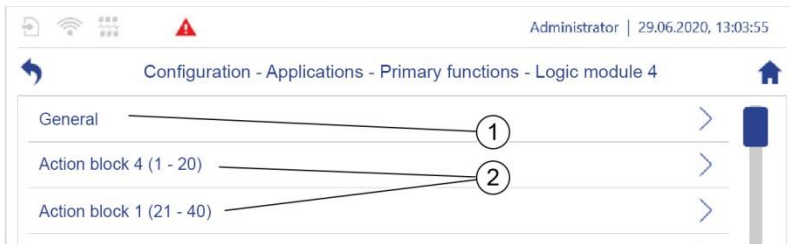

Config_Logic-module-4-01.png

Fig. 77: “Logic module 4”

5. Navigating to the required parameters:

- “General” (Fig. 77/1, ↪ “Setting parameters for the logic module’s markers” on page 139, ↪ “Defining the number and sequence of action blocks” on page 140).
- “Action block x” (Fig. 77/2, ↪ “Adding actions to an action block or deleting actions from an action block” on page 141, ↪ “Setting parameters for the logic module’s actions” on page 143).

Setting parameters for the logic module’s markers

You can set parameters for up to 5 logic module markers. You can use software switches to set the value “1” = “true” or the value “0” = “false” for each marker.

1. In the logic module’s configuration menu, tap “General”.

- ⇒ “Configuration – Applications – Primary functions – Logic module 1 – General” (Fig. 78).

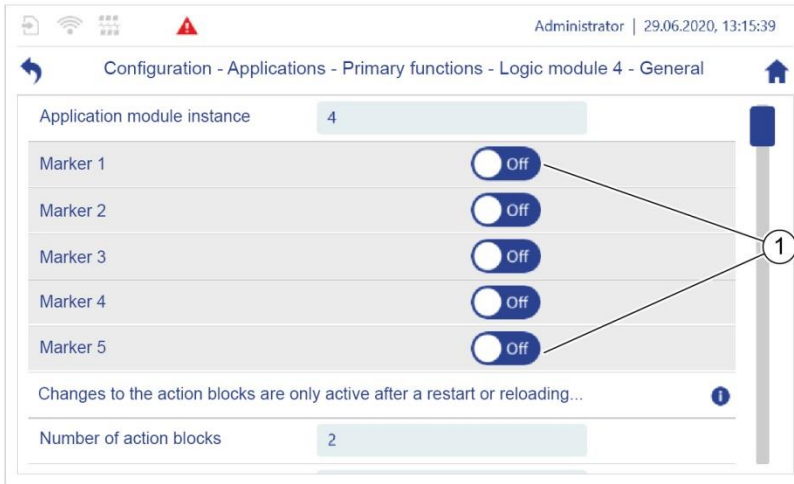

Config_Logic-module_General01.png

Fig. 78: “General”

- 1
 - ON: The marker has the value “1” = “true”.
 - OFF: The marker has the value “0” = “false”.
2. Set the parameters for the required number of markers (Fig. 78/1).

Defining the number and sequence of action blocks

Each logic module can run up to 6 action blocks in sequence. Parameters can be set for up to 20 actions in each action block.

The available action blocks are numbered 1 – 6.

The number and sequence of action blocks cannot be changed as long as the corresponding application module is active.

Changes to the settings for the action blocks only take effect after restarting the pump controller.

1. Ensure that the logic module that you wish to edit is deactivated.
2. In the logic module’s configuration menu, tap “General”.
 - ⇒ “Configuration – Applications – Primary functions – Logic module 4 – General” (Fig. 79) opens.



Config_Logic-module_4_General(02).png

Fig. 79: "General"

3. Enter the required number of action blocks (Fig. 79/1).
4. If several action blocks are defined, specify the sequence in which the action blocks should run. To do so, type the numbers for the action blocks that the application module should run into the input fields in the required sequence (Fig. 79/2).
 - ⇒ The action block number that you enter into the "Action block 1" input field will run first.
 - ⇒ The action block number that you enter into the "Action block 6" input field will run last.
5. Restarting the pump controller: ↪ Section 5.6.2.7 "Device restart" on page 201.

Adding actions to an action block or deleting actions from an action block

Actions of action blocks action run according to their number sequence. This means that in an action block that contains actions 21 - 40, action 21 runs first and action 40 runs last.

As soon as an action for which no command parameters have been set runs, no further actions are executed. This means that if parameters are set for actions 1 – 10 in an action block and no command parameters are set for action 11, only actions 1 – 10 run.

You can use the “Add / delete action” function to add another action or delete an action within one of these sequences of actions for which parameters have been set.

When inserting actions, note that an action block cannot contain more than 20 actions. If you add another action to an action block, the last action in the action block is deleted automatically.

1. In the configuration menu for the logic module, select the required action block, e.g. Action block 4.
 - ⇒ “*Configuration – Applications – Primary functions – Logic module 1 – Action block 4*” opens.
2. Tap “*Add / delete action*”.
3. If a new action is to be added to the action block:
 - Enter the action number before which the new action is to be inserted into the input field.
 - Tap “*Add*”.
 - ⇒ The new action is inserted at the required point.
 - ⇒ All subsequent actions are moved one place backwards.
4. If an action is to be deleted from the action block:
 - Enter the action number that is to be deleted into the input field.
 - Tap “*Delete*”.
 - ⇒ The action is deleted.
 - ⇒ All subsequent actions are moved one place forwards.

Setting parameters for the logic module's actions

- In the configuration menu for the logic module, select the action block for which parameters are to be set for its actions, e.g. action block 4.
 - ⇒ “*Configuration – Applications – Primary functions – Logic module 4 – Action block 4*” opens.
- Tap the required action, e.g. “*Action 1*”.
 - ⇒ “*Configuration – Applications – Primary functions – Logic module 4 – Action block 4 – Action 1*” (Fig. 80–Fig. 85) opens.

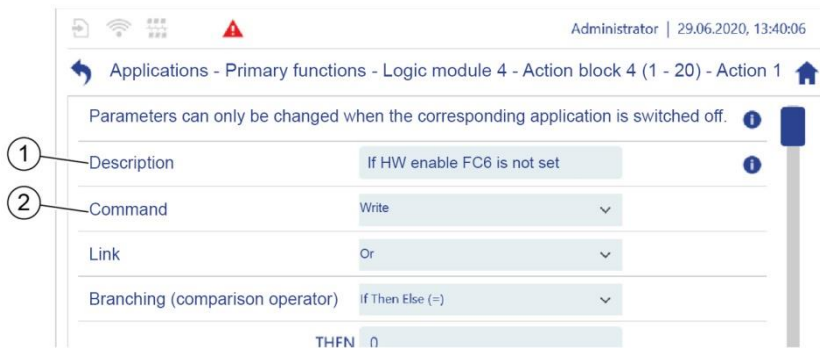

Fig. 80: “Action 1”

- | | | | |
|---|---------------------------------|---|-----------------------------------------------------------------------------------------------------------------------------------------------------------------------------------------------------------------------------------------------------------------------------------------------------------------|
| 1 | Specifies the action’s purpose. | 2 | Displays the type of command: |
| | | | <ul style="list-style-type: none"> • No command ¹⁾ • Copy • Write • Generate event • Go to action • Add • Subtract • Multiply • Divide • Reset lead time timer • Reset follow-up time timer |

¹⁾ Default setting for actions without parameters set. As soon as an action for which “No command” is set runs, no further actions are executed.

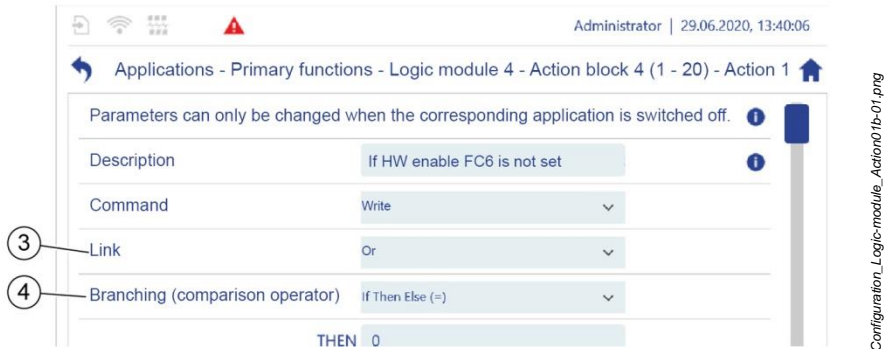

Fig. 81: "Action 1", continued

- | | |
|-----------------------------------------------------------------------------------------------------------|-------------------------------------------------------------------------------------------------------------------------------------------------------------------------------------------------------------------------------------------------------------------------------------------------------------------------------------------------------------------------------------------------------------------------------------------------------------------------------------------------------------------------------------------|
| <p>3 Displays the type of link:</p> <ul style="list-style-type: none"> • Or • And | <p>4 Displays the type of branching (with or without ELSE command) and the operator:</p> <ul style="list-style-type: none"> • No branching ¹⁾ • IF THEN (=) • IF THEN (< >) • IF THEN (>) • IF THEN (> =) • IF THEN (<) • IF THEN (< =) • IF THEN ELSE (=) • IF THEN ELSE (< >) • IF THEN ELSE (>) • IF THEN ELSE (> =) • IF THEN ELSE (<) • IF THEN ELSE (< =) |
|-----------------------------------------------------------------------------------------------------------|-------------------------------------------------------------------------------------------------------------------------------------------------------------------------------------------------------------------------------------------------------------------------------------------------------------------------------------------------------------------------------------------------------------------------------------------------------------------------------------------------------------------------------------------|

¹⁾ Default setting for actions without parameters set. This default setting causes the THEN command to be executed if the action runs without a condition being checked first.

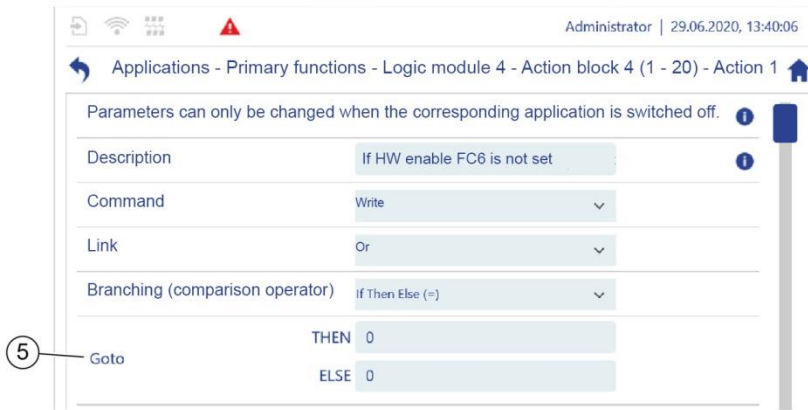

Fig. 82: "Action 1", continued

- 5 Indicates which action is executed after the current action:
- If a number from 1 – 120 is set for THEN or ELSE, the logic module next executes the action with the set number in the corresponding branch (THEN or ELSE).
Example:
If "3" is set at this point for THEN in the menu for action 4 and the condition for executing the action is true, action 3 is executed next.
 - If "0" is set for THEN or ELSE, the next action number is executed.
Example:
If "0" is set at this point for THEN or ELSE in the menu for action 4 and the condition for executing the action is true, action 5 is executed next.

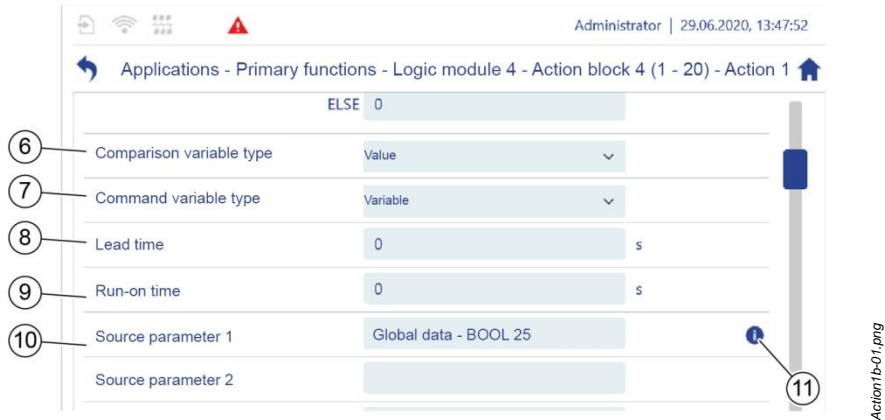
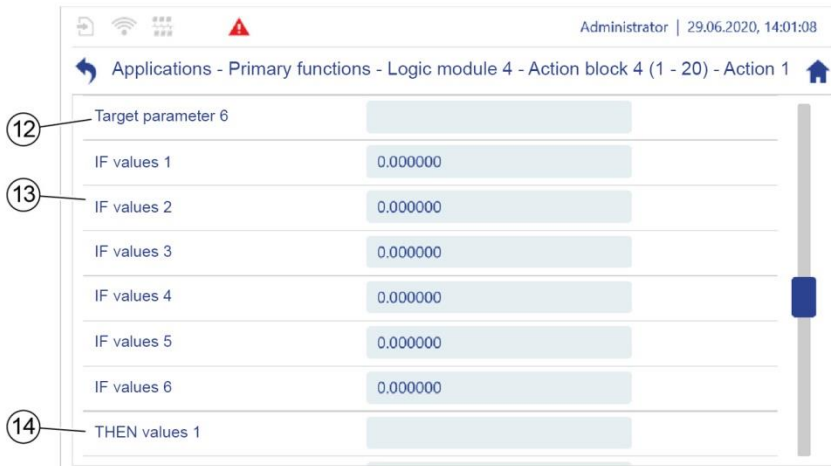

Fig. 83: “Action 1”, continued

- | | |
|-----------------------------------------------------------------------------------------------------------------------------------------------------------------------------------------------------------------------------------------------------------------------------------------------------------------------|-------------------------------------------------------------------------------------------------------------------------------------------------------------------------------------------------------------------------------------------------------------------------------------|
| <p>6 Indicates the way in which the values for the comparison variables can be selected:</p> <ul style="list-style-type: none"> • Value: You can type in the values for the comparison variables freely. • Variable: Copies the values from markers or from parameters in the parameter list. | <p>9 Displays the follow-up time that is set.</p> |
| <p>7 Indicates the way in which the values for the command variables can be selected:</p> <ul style="list-style-type: none"> • Value: You can type in the values for the command variables freely. • Variable: Copies the values from markers or from parameters in the parameter list. | <p>10 Displays source parameters 1 – 6. The values of several or all source parameters may be identical. For example, <i>Marker 1</i> can be set for each of the source parameters 1 – 6. In this way, the “Copy” command can copy the same value to several target parameters.</p> |
| <p>8 Displays the lead time that is set.</p> | <p>11 Opens a dialogue box that displays the contents of the adjacent input field completely, e.g. a parameter's path.</p> |



Configuration_Logic-module_Action03-01.png

Fig. 84: "Action 1", continued

- 12 Displays target parameters 1 – 6.
- 13 Displays IF values 1 – 6.
The number of IF values must correspond to the number of source parameters.
The values of several or all IF values may be identical. In this way, several source parameters can be compared with the same value.
- 14 Displays THEN values 1 – 6.
The values of several or all THEN values may be identical. In this way, the same value can be written to several target parameters.



Fig. 85: “Action 1”, continued

- | | |
|----------------------------------------------------------------------------------------------------------------------------------------------------------------------------------------------------------------------------------|------------------------------------------------------------------------------------------------------------------------------------------------------------------------------|
| <p>15 Displays ELSE values 1 – 6. The values of several or all ELSE values may be identical. In this way, the same value can be written to several target parameters.</p> <p>16 Displays the event ID for the event message.</p> | <p>17 Displays whether the event message has to be acknowledged. On: The event message must to be acknowledged. Off: The event message does not need to be acknowledged.</p> |
|----------------------------------------------------------------------------------------------------------------------------------------------------------------------------------------------------------------------------------|------------------------------------------------------------------------------------------------------------------------------------------------------------------------------|
3. Assign a description for the action (Fig. 80/1).
 4. Set a command (Fig. 80/2).
 5. Set the type of link as follows (Fig. 81/3):
 - If an AND link is required: Select *And*.
 - If an OR link or no link is required: Select *Or*.
 6. Set the type of branch (Fig. 81/4).



If you set an IF THEN branch, you cannot assign an event ID to trigger an event message to the action. If the action is to trigger an event message, you must set an IF THEN ELSE branch.

7. Select how the values for the action's comparison variables are defined.
 - If a freely-selectable value is to be typed in, set "Value" (Fig. 83/6).
 - If you wish to use the value of a parameter or a marker, set "Variable" (Fig. 83/6).
8. Select how the values for the action's command variables are defined.
 - If a freely-selectable value is to be typed in, set "Value" (Fig. 83/7).
 - If you wish to use the value of a parameter or a marker, set "Variable" (Fig. 83/7).
9. Set the lead time (Fig. 83/8)
 - If the THEN command is to be delayed by a lead time, set the required lead time.
 - If no lead time is required, ensure that the lead time is set to 0.
10. Set the run-on time (Fig. 83/9)
 - If the ELSE command is to be delayed by a follow-up time, set the required follow-up time.
 - If no follow-up time is required, ensure that the follow-up is set to 0.
11. Define the required number of source parameters (Fig. 83/10).
12. Define the values for the required number of IF values (Fig. 84/13).
13. Set or delete the event ID (Fig. 85/16):
 - If the command is to trigger an event message, enter the event ID for the required event message.
 - If the command is not to trigger an event message, ensure that event ID 000000 is displayed.
14. Set whether the event message must be acknowledged (Fig. 85/17):
 - If the event message does not need to be acknowledged, set the software switch to *Off*.
 - If the event message must be acknowledged, set the software switch to *On*.

⇒ If the "Generate event" command is set for the action, the parameters for the action have been set completely.
15. Depending on the command set, proceed as follows:
 - ↻ 'Setting the parameters for the action with the "Copy" command' on page 150
 - ↻ 'Setting the parameters for the action with the "Write" command' on page 150
 - ↻ 'Setting the parameters for the action with the "Go to action" command' on page 150

- ↪ ‘Setting the parameters for the action with the “Add” command” *on page 151*
- ↪ ‘Setting the parameters for the action with the “Subtract”, “Multiply” or “Divide” command” *on page 152*
- ↪ ‘Setting the parameters for the action with the “Reset lead time timer” command” *on page 152*
- ↪ ‘Setting the parameters for the action with the “Reset follow-up time timer” command” *on page 152*

16. Check that the parameters in the actions for which parameters were set are correct (↪ ‘Checking that the action’s parameters are correct” *on page 153*)

Setting the parameters for the action with the “Copy” command

The “Copy” command copies the values from source parameters to target parameters.

▶ Define the required number of target parameters (Fig. 84/12).

Setting the parameters for the action with the “Write” command

The “Write” command writes THEN or ELSE values to target parameters.

Example:

ELSE value 1 = “5”

ELSE value 2 = “true”

ELSE value 3 = “-5.34”

This results in the following target values:

Target parameter 1 = “5”

Target parameter 2 = “true”

Target parameter 3= “-5.34”

1. Define the required number of target parameters (Fig. 84/12).
2. Define the values for the required number of THEN values (Fig. 84/14).
3. Define the values for the required number of ELSE values (Fig. 85/15).

Setting the parameters for the action with the “Go to action” command

If the “Go to action” command is executed, a jump is performed within the action block to the action with the number that is set as the THEN value or the ELSE value.

Example:

The “Go to action” command is set as the parameter for action 6. The THEN value for this action is “3”. If the condition for executing the command is true, action 3 in the action block is executed after action 6.

1. In “*THEN*”, set the action number that is to run when the THEN command is executed (Fig. 82/5).
2. In “*ELSE*”, set the action number that is to run when the ELSE command is executed (Fig. 82/5).

Setting the parameters for the action with the “Add” command

The “Add” command adds the THEN values or the ELSE values to the target parameter values.

Example:

Before executing the action, the parameters have the following values:

G.REAL 1 = “4”

G.REAL 2 = “10.5”

G.REAL 3 = 0

The following target parameters are set for the action:

Target parameter 1 =G.REAL 3

Target parameter 2 =G.REAL 3

The following THEN values are set for the action:

THEN value 1 = G.REAL 1

THEN value 2 = G.REAL 2

When the THEN command is executed, the THEN values are added to the target parameters:

THEN value 1 + target parameter 1:

$G.REAL 3 = G.REAL 3 + G.REAL 1 = 0 + 4 = 4$

THEN value 2 + target parameter 2:

$G.REAL 3 = G.REAL 3 + G.REAL 2 = 4 + 10.5 = 14.5$

This results in:

G.REAL 3 = 14.5

1. Define the required number of target parameters (Fig. 84/12).
2. Define the values for the required number of THEN values (Fig. 84/14).

3. Define the values for the required number of ELSE values (Fig. 85/15).

Setting the parameters for the action with the “Subtract”, “Multiply” or “Divide” command

The parameters for the “Subtract”, “Multiply” and “Divide” commands are set according to the same rules as the “Add” command.

1. Define the required number of target parameters (Fig. 84/12).
2. Define the values for the required number of THEN values (Fig. 84/14).
3. Define the values for the required number of ELSE values (Fig. 85/15).

Setting the parameters for the action with the “Reset lead time timer” command

As soon as the THEN command is executed for an action for which a lead time is set, the timer starts the lead time (lead time timer).

The lead time timer is reset to “0” automatically if no THEN command is executed, but rather an ELSE command or no command is executed.

You can use the “Reset lead time timer” command to reset and stop up to 6 lead time timers simultaneously. To do this, you must define the action numbers for which the lead time timer is to be reset and stopped as THEN or ELSE values.

Example:

A lead time is set for both action 3 and action 7.

For action 10, the “Reset lead time timer” and the following THEN values are set:

THEN value 1 = “3”

THEN value 2 = “7”.

When the THEN command is executed, the lead times for action 3 and action 7 are stopped and the lead time timers for these actions are reset to “0”.

1. Define the values for the required number of THEN values (Fig. 84/14).
2. Define the values for the required number of ELSE values (Fig. 85/15).

Setting the parameters for the action with the “Reset follow-up time timer” command

As soon as the ELSE command is executed for an action for which a follow-up time is set, the timer starts the follow-up time (follow-up time timer).

The follow-up time timer is reset to “0” automatically if no ELSE command is executed, but rather a THEN command or no command is executed.

You can use the “Reset follow-up time timer” command to reset and stop up to 6 follow-up time timers simultaneously. To do this, you must define the action numbers for which the follow-up time timer is to be reset and stopped as THEN or ELSE values.

Example:

A follow-up time is set for both action 3 and action 7.

For action 10, the “Reset follow-up time timer” and the following THEN values are set:

THEN value 1 = “3”

THEN value 2 = “7”.

When the THEN command is executed, the follow-up times for action 3 and action 7 are stopped and the follow-up time timers for these actions are reset to “0”.

1. Define the values for the required number of THEN values (Fig. 84/14).
2. Define the values for the required number of ELSE values (Fig. 85/15).

Checking that the action’s parameters are correct



1. Tap  next to an input field (Fig. 83/8).
 - ⇒ The complete designation for the setting or the complete path for the parameter set is displayed.
2. Check that the parameters are correct.

5.4.6.5 Using the logic module during operation

You can use the application single view to start the logic module.

Prerequisites:

The parameters for the required logic module are set correctly and assigned to an application module:

-  *Section 5.3.1 “Checking the assignments to application modules” on page 92*
-  *Section 5.7.3 “Using the application overview during operation” on page 227*



As soon as an application module with the “Logic module” primary function is activated, the pump controller checks the actions for which parameters were set automatically. If an error in the parameter settings is detected, the application module is automatically deactivated and an error message issued.

1. In the “*Application overview*” (↪ *section 5.7.3 ‘Using the application overview during operation’ on page 227*), tap the application module with the “Logic module” primary function.
 - ⇒ The application single view for the logic module (Fig. 86) opens.

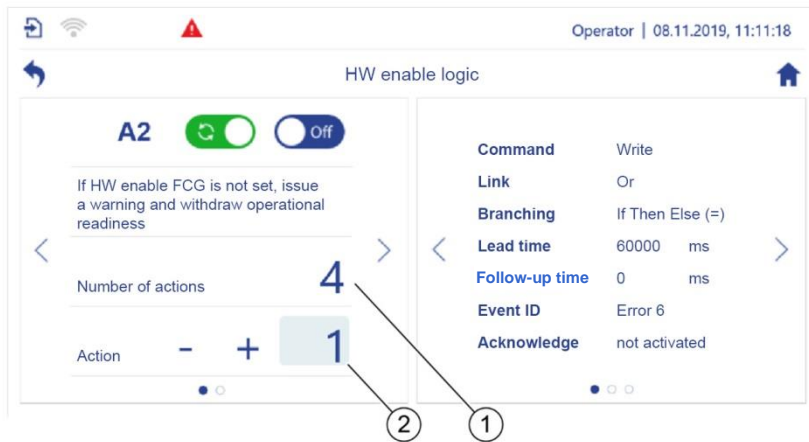

Application-single-view_CSM-01.png

Fig. 86: Application single view for a logic module

- 1 Displays the number of actions for which parameters were set for the logic module. The number of actions does not have to match the number of the last action for which parameters were set, as the “Go to action” command can be used to bypass functions.
 - 2 Displays the number of the selected action. The number of available actions do not have to be sequential, as the “Go to” command can be used to bypass functions.
2. Select an action for the logic module in the application single view's left display area. To do so, either use **+** and **-** to select an action or enter an action number in the input field (Fig. 86/2).
 - ⇒ The right display area displays the settings for the selected action.
 3. Use **>** to scroll one screen forward in the left display area.
 - ⇒ The left display area displays the designations for the source and target parameters defined for the action (Fig. 87/1).

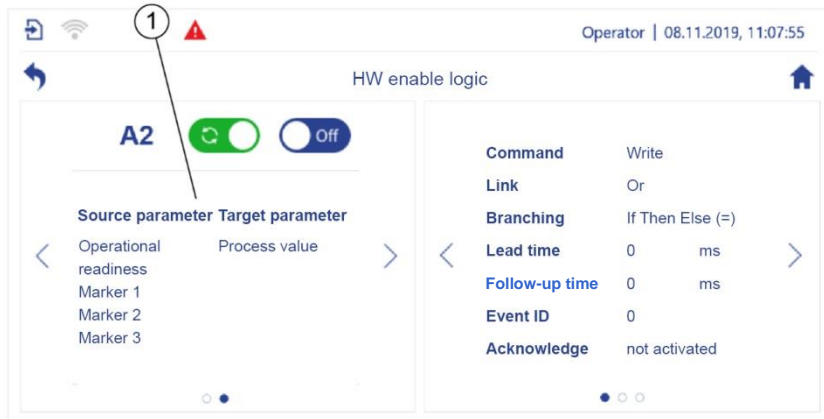
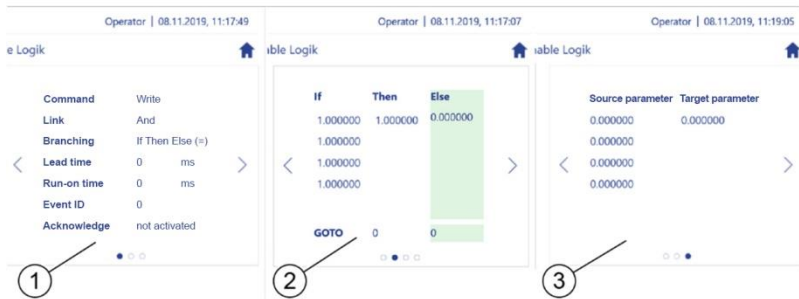

Fig. 87: Designations of the source and target parameters

4. If required: If you use remote access to operate the pump controller with a web browser, move the mouse pointer over a parameter to display the parameter's complete path.
5. In the right display area, use < or > to display all settings for the action (Fig. 88/1 – 3).



Application-single-view_Status-window_Properties-01.png

Fig. 88: Action settings

- 1 Displays the configured structure of the logic function.
- 2 Displays the values of the IF, THEN and ELSE values.
 - If the logic module is active: The green mark designates the command that is currently being executed by the action (THEN command or ELSE command).
 - An orange marking can have the following meanings:
 - The condition is “false” but no ELSE command is defined.
 - A THEN command or an ELSE command should be executed but the lead time or follow-up time has not yet elapsed.
 - GOTO: displays the THEN value and the ELSE value for the “Go to action” command. If “0” is displayed, no “Go to action” command is executed.
- 3 Displays the values of the source and target parameters.

5.5 Secondary functions

Secondary functions are used to expand primary functions.

This section describes the possible secondary functions. The secondary functions that are available to you depend on the pump controller configuration file that is used. Only the manufacturer can edit the configuration file.



If there are problems with the configuration, contact customer service:

- When doing so, provide the current configuration file
 - ↳ *Section 7.2.1 “Backup and restore preparation” on page 250.*
 - Or:
- Have the pump controller’s order number and serial number at hand.
 - ↳ “Customer service” on *page 8*

5.5.1 Offset control

The offset control is used to limit the pressure and to extend the permissible working range of a screw spindle pump. In the offset control, a preselected pressure opens a pressure control valve in order to prevent pressure peaks.

Using offset control

Prerequisites:

The “Offset control” secondary function is assigned to an application module with the “Control mode” primary function that controls the “Pressure” process size:

- ↳ *Section 5.3.1 “Checking the assignments to application modules” on page 92*
- ↳ *Section 5.7.3 “Using the application overview during operation” on page 227*



For information regarding the offset control, also see

- ↳ *Section 5.6.1.2 “Setting parameters for analog inputs and outputs” on page 173.*



The procedure is based on ↪ *Section 5.4.2 "Executing control mode with one pump" on page 103.*

Set the application module as described there.

5.5.2 Wear detection

The "Wear detection" secondary function is only available for immersed screw spindle pumps of a suitable design size. You can obtain information regarding which design sizes are suitable from the pump controller manufacturer.

Wear detection is used to determine the wear condition of immersed screw spindle pumps and to forecast the development of the wear condition over a pre-determined forecast period.

To do this, wear detection measures how quickly the screw spindle pump must rotate in order to convey medium at a pre-set pressure. Wear detection compares the measurement result with the results of previous wear measurements and determines whether the pump performance has changed since the last wear measurement.

In this way, wear detection can calculate the number of operating hours for which the screw spindle pump can remain in use with the same operating conditions before it becomes damaged by wear.

To do this, wear detection must cyclically perform a regular wear measurement depending on the operating condition of the screw spindle pump. The more demanding the operating conditions, the more frequently measurements have to be made.

5.5.2.1 Setting wear detection parameters

All user groups can check that the wear detection parameters are correct. The following user groups can also set the forecast period.

- Service
- Admin

The forecast period is the period for which wear detection forecasts the pump wear that is to be expected.

After the forecast period has expired, the pump controller displays a warning that reminds you to perform another wear measurement.



- Most settings are pre-configured by the manufacturer.
- Check that the settings are correct before commissioning for the first time.
- If there are problems with the configuration, contact customer service:
 - When doing so, provide the current configuration file
↳ *Section 7.2.1 “Backup and restore preparation” on page 250.*
 - Or:
 - Have the pump controller’s order number and serial number at hand.
↳ *“Customer service” on page 8.*

1. Tap ⓘ in the navigation bar.
⇒ The “*Configuration*” menu opens.
2. In the “*Configuration*” menu, tap “*Applications*”.
⇒ “*Configuration – Applications*” opens.
3. In “*Configuration– Applications*”, tap “*Secondary functions*”.
⇒ “*Configuration – Applications – Secondary functions*” (Fig. 89) opens.

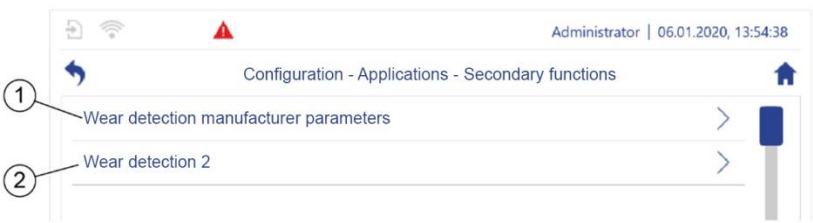

Config_Secondary-functions-01.png

Fig. 89: “*Secondary functions*”

4. Tap “*Manufacturer parameters - Wear detection*” (Fig. 89/1).
5. Tap wear detection for the required screw spindle pump, e.g. “*Wear detection 2*” (Fig. 89/2).

- ⇒ The “*Configuration – Applications – Secondary functions – Wear detection 2*” (Fig. 90) menu opens.

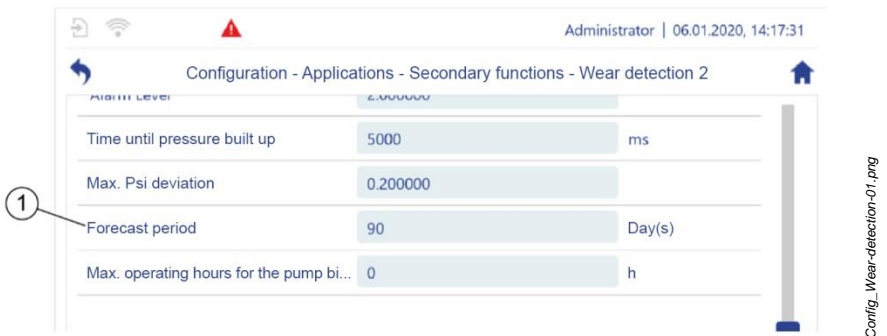

Fig. 90: “*Wear detection 2*”

6. Set the required forecast period (Fig. 90/1).
7. Check that the remaining settings are correct.

5.5.2.2 Performing wear detection and reading the pump condition

The “Wear detection” secondary function adds two screens to the pump single view’s left display area and one screen to the pump single view’s right display area (Fig. 91 and Fig. 92). You can start wear measurement and read the results on these screens.

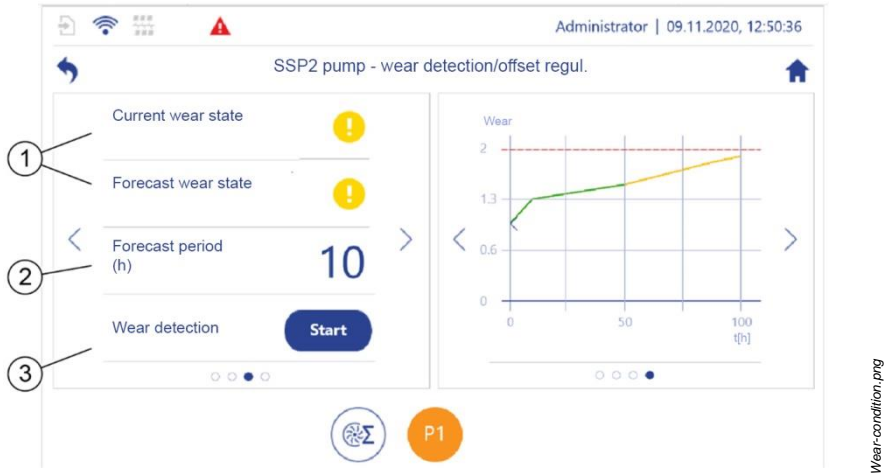

Fig. 91: Overview of the pump’s wear condition

- 1 Displays the pump’s current wear condition and the forecast wear condition that the pump will have at the end of the forecast period.
 - : Normal mode. No special measures are required.
 - : significant characteristic curve decline, risk of increased vibration values and operating noises. The pump should be checked.
 - : Risk of irreparable pump damage, generally highly increased vibrations and operating noises. The pump controller displays an error message. The pump must be repaired or replaced.
- 2 Displays the period, at the end of which the pump will have the forecast condition (Fig. 91/1).
- 3 Starts wear measurement.

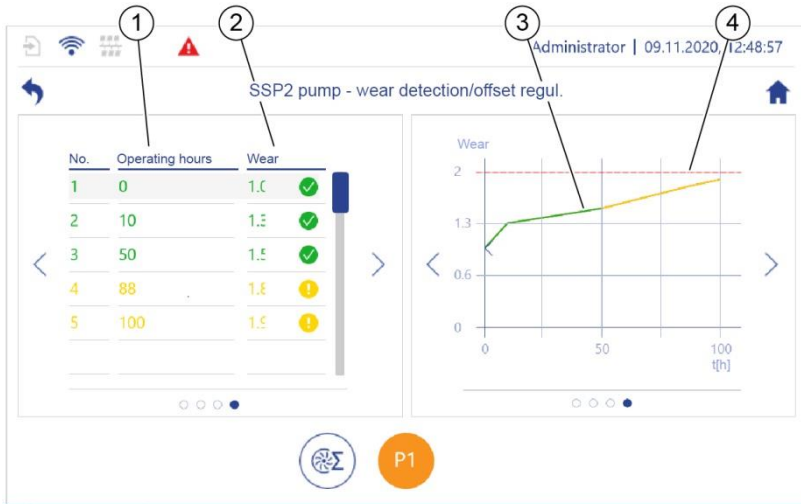

Fig. 92: Result of wear measurement

- 1 Displays the number of pump operating hours since the last wear measurement was performed.
- 2 Displays the measurement results of the last wear measurement.
 - ✓: Normal mode. No special measures are required.
 - ⚠: Significant characteristic curve decline, risk of increased vibration values and operating noises. The pump should be checked.
 - ⚠: Risk of irreparable pump damage, generally highly increased vibrations and operating noises. The pump controller displays an error message. The pump must be repaired or replaced.
- 3 The curve represents the development of the wear condition determined to the current wear condition graphically.
- 4 The red line indicates the wear condition as of which the pump can suffer irreparable damage.

Performing wear measurement

The frequency with which wear measurement must be performed depends on how frequently and how heavily the screw spindle pump is strained. Perform wear measurement at least after one third of the forecast period.

Example:

If a forecast period is set to 90 days, a wear measurement must be performed every 30 days if operation remains the same.

Prerequisites

- The application module to which the pump that has to be checked is assigned does not indicate any errors.
- The application module to which the pump that has to be checked is assigned has been activated.



NOTICE!

False measurement results due to bypass leaks!

Bypass leaks, e.g. due to pressure limitation valves, can falsify the measurement results. Therefore, wear detection determines greater wear on the pump than is actually present. As a result, a functioning pump may be indicated as requiring maintenance or repair for example.

- Only perform wear detection in a system that is secured to prevent bypass leaks.
- Only perform wear detection for immersed screw spindle pumps of a suitable design size.

1. Call the pump single view for the pump that is to be checked.
2. In the pump single view's left display area, use < or > to scroll until the overview of the wear condition (Fig. 91/1) is displayed.
3. Tap the "Start" button.
 - ⇒ A wizard with a user guide (Fig. 93) opens.

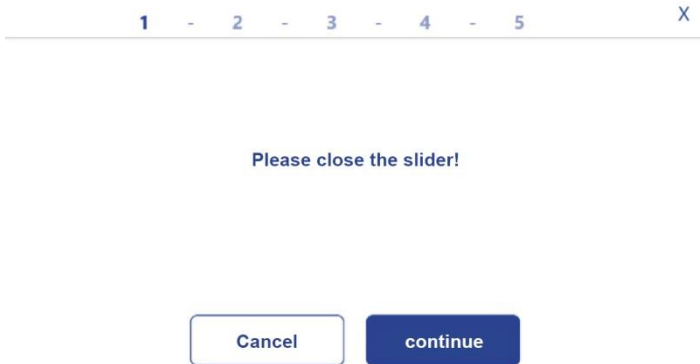

Wear-detection_Wizard.png

Fig. 93: Wear detection wizard

4. Follow the wizard's instructions.

Displaying the pump's wear condition

1. Open the pump single view for the pump that was checked.
2. In the pump single view's left and right display area, use < or > to scroll until the results of wear measurement are displayed (Fig. 91 and Fig. 92 on page 162 and 163).
3. Maintain, repair or replace the pump depending on the current wear condition.

5.6 Setting pump controller parameters

This section describes the maximum available parameter setting options. The parameter setting options that are available on your pump controller depend on the pump controller configuration file that is used.

All pump controller setting parameters that you can save have a white background (Fig. 94/1).

All pump controller setting parameters that you cannot save have a grey background (Fig. 94/2).

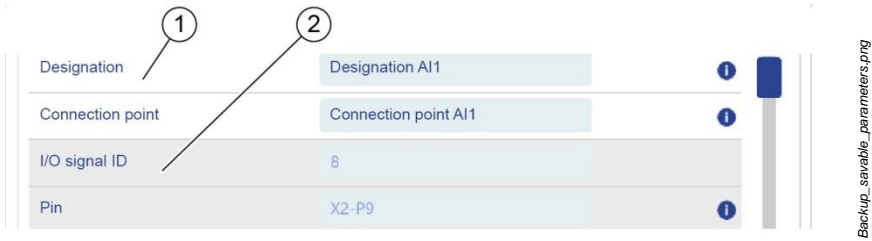



Fig. 94: Setting parameters that can and cannot be saved on the pump controller

Opening the basic settings for setting parameters



Configuration-menu.png

Fig. 95: “Configuration”

1. Tap  in the navigation bar.
 - ⇒ The “Configuration” (Fig. 95) view opens.
2. Navigate as follows depending on the required settings:
 - I/O configuration: Fig. 95/4
 - ↳ Section 5.6.1 “Setting I/O parameters” on page 168
 - Pumps: Fig. 95/6
 - ↳ Section 5.6.1.5 “Setting pump parameters” on page 183
 - System: Fig. 95/1
 - ↳ Section 5.6.2 “System settings” on page 190
 - LAN and WLAN: Fig. 95/2
 - ↳ Section 5.6.3 “Setting LAN parameters” on page 202
 - ↳ Section 5.6.4 “Setting WLAN module parameters” on page 205
 - ↳ Section 6.2 “WLAN” on page 244
 - Field bus: Fig. 95/3
 - ↳ Section 5.6.5 “Checking field bus parameters” on page 208
 - Applications: Fig. 95/5
 - ↳ Section 5.3 “Application modules” on page 91



For more details, also see ↪ *Section 6 “Additional functions” on page 239.*

5.6.1 Setting I/O parameters

You can connect the sensors and actuators directly to the pump controller’s I/O module or to the frequency converter’s I/Os. Setting parameters via the pump controller works in the same way in both cases.

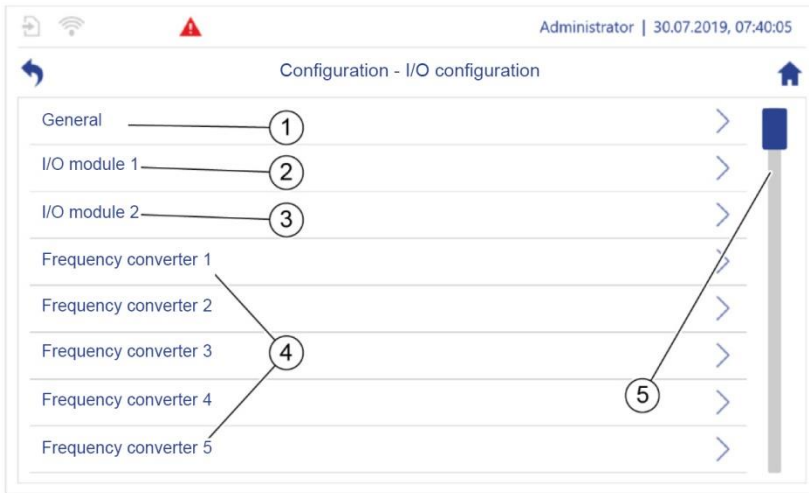

Configuration-menu-for_I/O_configuration.png

Fig. 96: “I/O configuration”

3. In “Configuration”, tap “I/O configuration”.
 ⇒ “Configuration – I/O configuration” (Fig. 96) opens.

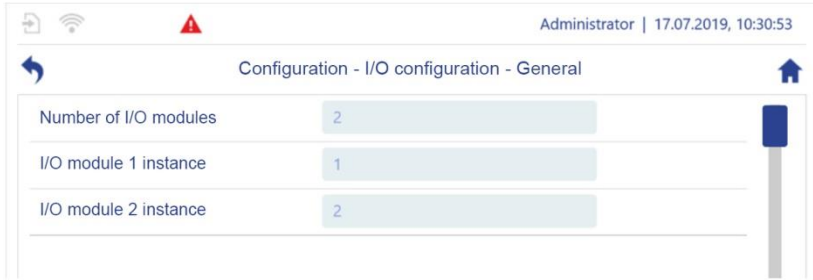

Fig. 97: "I/O selection"

4. Navigate as follows depending on the required settings:

- Fig. 96/1: "I/O selection" (Fig. 97, general specifications for the I/O modules, pre-set by the manufacturer)



- The settings are pre-configured by the manufacturer.
- Check that the settings are correct before commissioning for the first time.
- If there are problems with the configuration, contact customer service:
 - When doing so, provide the current configuration file
 - ↳ Section 7.2.1 "Backup and restore preparation" on page 250.
 - Or:
 - Have the pump controller's order number and serial number at hand.
 - ↳ "Customer service" on page 8

- Fig. 96/2 – 3: ↳ Section 5.6.1.1 "Setting parameters for digital inputs and outputs" on page 170
- Fig. 96/4: ↳ Section 5.6.1.4 "Setting actuator parameters" on page 180
- Fig. 96/5: scroll in order to display additional frequency converters

5.6.1.1 Setting parameters for digital inputs and outputs

A designation and a name for the connection point can be assigned to each digital input and digital output. Furthermore, you can define whether the pump controller inverts the signal of the sensor that is connected.

In addition, you can define whether you want to use each digital output of I/O module 1 as an output or an input.

All other settings for the digital inputs and outputs are specified by the manufacturer and must be checked before commissioning.

1. In “*Configuration*”, tap “*I/O configuration*”.
⇒ “*Configuration – I/O configuration*” (Fig. 96) opens.
2. In “*I/O configuration*”, tap the required I/O module or the required frequency converter, e.g. “*I/O module 1*”.
⇒ “*Configuration – I/O configuration – I/O module 1*” (Fig. 98) opens.

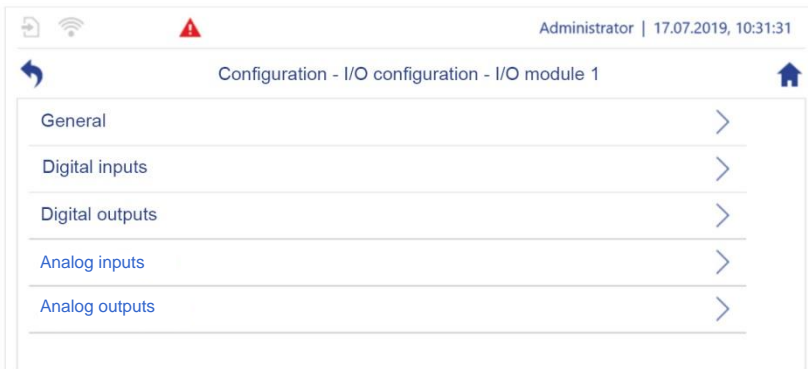

Configuration-module1.png

Fig. 98: “*I/O module 1*”

3. Either tap “*Digital inputs*” or “*Digital outputs*”.
⇒ “*Digital inputs*” or “*Digital outputs*” opens (Fig. 99). A list of the available digital inputs or digital outputs is displayed.

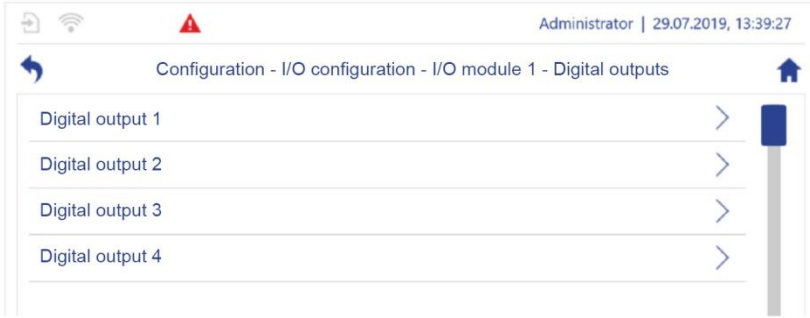

Configuration_digital-outputs-01.png

Fig. 99: "Digital outputs"

4. In "Digital inputs", tap the required digital input or, in "Digital outputs", tap the required digital output, e.g. "Digital output 1".

⇒ "Digital output 1" (Fig. 100) opens.

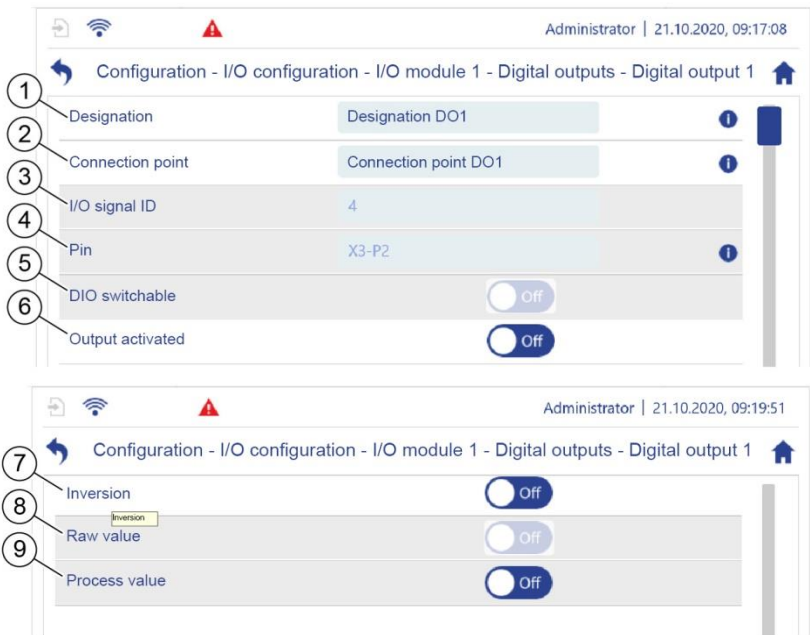

Config-digital-output1a.png

Config-digital-output1b.png

Fig. 100: "Digital output 1" (example)

- | | | | |
|---|-----------------------------------------------------------------------------------------------------------------------------------------------------------------------------------------------------------------------------------------------------------------------------|---|----------------------------------------------------------------------------------------------------------------------------------------------------------------------------------------------------|
| 1 | Input/output designation | 2 | Name of the connection point |
| 3 | I/O signal ID of the input/output: Identifier for a connection point (e.g. DI1) | 4 | I/O signal pin connection: <ul style="list-style-type: none">• X = M12 connection on the I/O module, X3 in the example• P = pin on the M12 connection, pin 2 in the example |
| 5 | Indicates whether this is a switchable output: <ul style="list-style-type: none">• ON: The output's function can be switched. The output can be used as an input.• OFF: The output's function cannot be switched. | 6 | If the output is switchable: <ul style="list-style-type: none">• ON: The output is used as an output.• OFF: The output is used as an input. |
| 7 | Indicates whether the pump controller inverts the logic of the sensor that is connected. <ul style="list-style-type: none">• ON: Inverts the logic of the sensor that is connected.• OFF: The logic of the sensor that is connected is not inverted. | 8 | Displays the raw value for the digital input or the digital output, i.e. without inversion. |
| 9 | Displays the process value for the digital input or output. <ul style="list-style-type: none">• ON: The process value is 1• OFF: The process value is 0 | | |

5. Make the required settings.
6. Check all settings for which parameters cannot be set.



- Many of the settings are pre-configured by the manufacturer.
- Check that the settings are correct before commissioning for the first time.
- If there are problems with the configuration, contact customer service:
 - When doing so, provide the current configuration file
 - ↳ *Section 7.2.1 “Backup and restore preparation” on page 250.*
 - Or:
 - Have the pump controller’s order number and serial number at hand.
 - ↳ *“Customer service” on page 8*

5.6.1.2 Setting parameters for analog inputs and outputs

A designation and a name for the connection point can be assigned to each analog input and analog output. Furthermore, you can switch the operating mode for the analog input or output between current mode and voltage mode.

All other settings for the analog inputs and outputs are specified by the manufacturer and must be checked before commissioning.

1. In *“Configuration”*, tap *“I/O configuration”*.
 - ⇒ *“Configuration – I/O configuration”* (Fig. 96) opens.
2. In *“I/O configuration”*, tap the required I/O module or the required frequency converter, e.g. *“I/O module 1”*.
 - ⇒ *“Configuration – I/O configuration – I/O module 1”* (Fig. 101) opens.

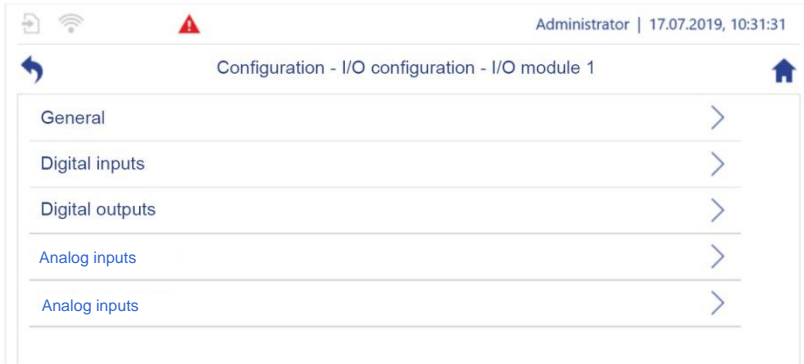

Configuration-module 1.png

Fig. 101: "I/O module 1"

3. Either tap "Analog inputs" or "Analog outputs".

⇒ "Analog inputs" or "Analog outputs" (Fig. 102) opens. A list of the available analog inputs or analog outputs is displayed.



Configuration_Analog-outputs.PNG

Fig. 102: "Analog outputs"

4. In "Analog inputs", tap the required analogue input or, in "Analog outputs", tap the required analog output, e.g. "Analog output 1".

⇒ "Analog output 1" (Fig. 103) opens.



Configuration_analog_input1f-01a.png

Configuration_analog_input1f-01.png

Fig. 103: Analog input/output (example)

1	Input/output designation	8 ¹⁾	Minimum process value for the sensor/actuator that is connected
2	Name of the connection point	9 ¹⁾	Maximum signal value for the sensor/actuator that is connected
3	I/O signal ID of the input/output: Identifier for a connection point (e.g. AI1)	10 ¹⁾	Minimum signal value for the sensor/actuator that is connected
4	I/O signal pin connection: <ul style="list-style-type: none"> • X = M12 connection on the I/O module, X2 in the example • P = pin on the M12 connection, pin 9 in the example 	11	Current signal value for the sensor/actuator that is connected. In an input with 4 – 20 mA, the value “2” indicates a cable break and the value “22” indicates a short circuit.
5	Indicates whether the operating mode for the input/output can be switched. On: The operating mode for the input/output can be switched. Off: The operating mode for the input/output cannot be switched.	12	Current process value for the sensor/actuator that is connected
6	On: Switches the operating mode for the input/output from current mode to voltage mode. Off: Switches the operating mode for the input/output to current mode. Changes to these settings only take effect after restarting the pump controller.	13	The raw value displays the value for the analog/digital converter.
7 ¹⁾	Maximum process value for the sensor/actuator		

¹⁾The sensors and actuators measure and set physical process sizes such as pressure or throughput. The sensors and actuators transmit the values for these process sizes to the pump controller via electrical signals such as electrical voltage in the range of 0 V - 10 V or current in the range of 4 mA - 20 mA.

Use the parameters for the minimum and maximum process values and signal values (Fig. 103/7–10) to define the measurement range for the sensor or actuator that is connected. The pump controller uses these parameters to

translate the electronic signals back into physical process sizes (example:

↳ Fig. 104 *on page 178*). The values to be set for these parameters are available on the data sheet for the sensor or actuator that is connected.

5. Set the minimum and maximum values for the process value for the sensor or actuator that is connected. To do this, take the required values from the data sheet for the sensor or actuator.
6. Set the minimum and maximum values for the signal value for the sensor or actuator that is connected. To do this, take the required values from the data sheet for the sensor.
7. Make all other required settings.
8. Check all settings for which parameters cannot be set.

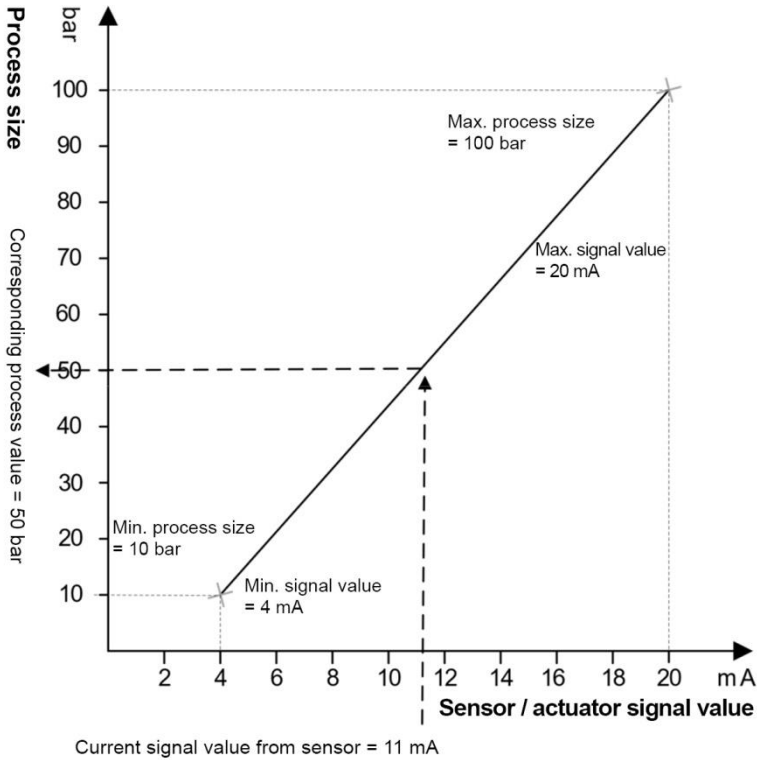

Sensor_actuator_scaling.svg

Fig. 104: Example: Converting a signal value into a physical process size



- Many of the settings are pre-configured by the manufacturer.
- Check that the settings are correct before commissioning for the first time.
- If there are problems with the configuration, contact customer service:
 - When doing so, provide the current configuration file
 - ↳ *Section 7.2.1 “Backup and restore preparation” on page 250.*
 - Or:
 - Have the pump controller’s order number and serial number at hand.
 - ↳ *“Customer service” on page 8*

5.6.1.3 Setting sensor parameters

Parameters are set in the same way for all sensors.

Prerequisite:

The sensors are connected properly ↳ *Section 4.3 “Connecting the pump controller electrically” on page 42.*



Also see the documentation for the sensors that are to be connected.

- ▶ Proceed as follows depending on the sensor used:
 - Check the configuration for sensors with a digital connection
 - ↳ *Section 5.6.1.1 “Setting parameters for digital inputs and outputs” on page 170.*
 - For sensors with an analog connection:
 - Enter the signal form (current/voltage), sensor process values and signal values (4 mA - 20 mA / 0 V - 10 V).
 - Check the remaining configuration.
 - ↳ *Section 5.6.1.2 “Setting parameters for analog inputs and outputs” on page 173*



- The remaining settings are pre-configured by the manufacturer.
- Check that the settings are correct before commissioning for the first time.
- If there are problems with the configuration, contact customer service:
 - When doing so, provide the current configuration file
↳ *Section 7.2.1 “Backup and restore preparation” on page 250.*
 - Or:
 - Have the pump controller’s order number and serial number at hand.
↳ “Customer service” on page 8

5.6.1.4 Setting actuator parameters

Parameters are set in the same way for all actuators.



- Most settings are pre-configured by the manufacturer.
- Check that the settings are correct before commissioning for the first time.
- If there are problems with the configuration, contact customer service:
 - When doing so, provide the current configuration file
↳ *Section 7.2.1 “Backup and restore preparation” on page 250.*
 - Or:
 - Have the pump controller’s order number and serial number at hand.
↳ “Customer service” on page 8

Setting frequency converter parameters

Prerequisite:

The frequency converters are connected properly ↳ *Section 4.3 “Connecting the pump controller electrically” on page 42.*



Also see the documentation for the frequency converters that are to be connected.

Also see [section 5.6.1.5](#) “Setting pump parameters” on page 183.

Frequency converter with its own I/O

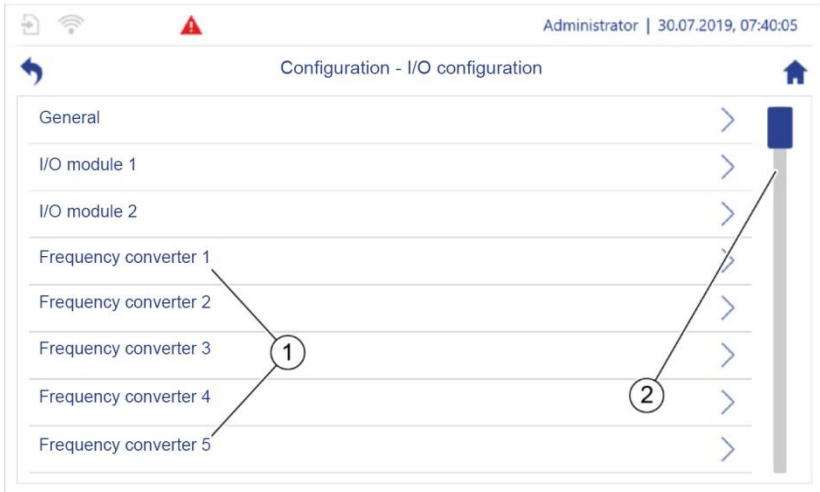

Configuration_I/O_frequency-converter.png

Fig. 105: “Configuration – I/O configuration”

1. In “Configuration – I/O configuration” (Fig. 105/1), tap the required frequency converter, e.g. “Frequency converter 1”.

To do this, also scroll in order to display additional frequency converters if required (Fig. 105/2).

⇒ “Frequency converter 1” is displayed.

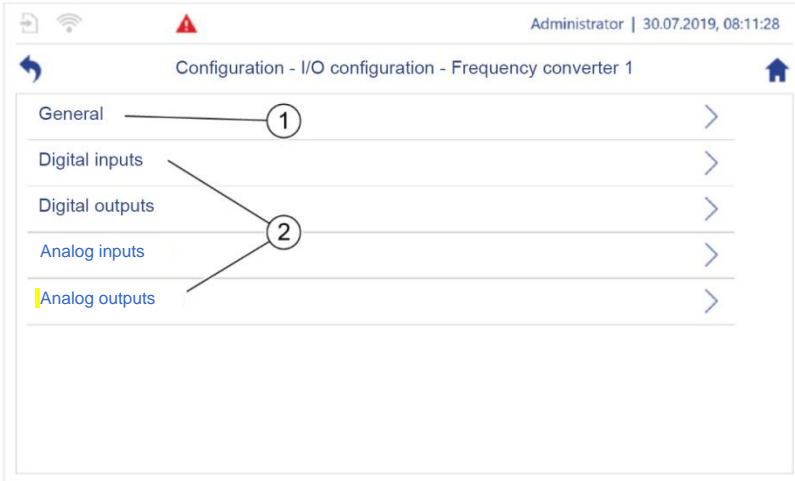

Configuration_I/O_frequency-converter1.png

Fig. 106: “Configuration – I/O configuration – Frequency converter 1”

2. In the “General” (Fig. 106/1) submenu, check the settings defined by the manufacturer.
3. In the “Frequency converter 1” menu, either tap “Digital inputs”, “Digital outputs”, “Analog inputs” or “Analog outputs” (Fig. 106/2) as required, e.g. “Digital inputs”.
 - ⇒ “Configuration – I/O configuration – Frequency converter 1 – Digital inputs” is displayed.
4. In “Configuration – I/O configuration – Frequency converter 1 – Digital inputs”, select the required digital input, e.g. “Digital input 1”.
 - ⇒ The “Digital input 1” menu is displayed.
5. Make the required settings or check them ↪ Section 5.6.1.1 “Setting parameters for digital inputs and outputs” on page 170 or section 5.6.1.2 “Setting parameters for analog inputs and outputs” on page 173.

5.6.1.5 Setting pump parameters

This section describes all adjustable pump-specific parameters. The settings for the *Hydraulics*, *Motor* and *Frequency converter* pump components are made separately in their own submenus.

In the settings menu for the *Hydraulics* pump component, you can also view the supporting points for the pump curves.

The pump controller uses the supporting points for throughput and pressure to calculate the pump's QH characteristic curve. The pump controller derives all other pump characteristic curves from the characteristic curve calculated.

The pump characteristic curves for a pump are displayed in the corresponding pump single view (↪ [section 5.7.3 "Using the application overview during operation" on page 227](#)).



- Most settings are pre-configured by the manufacturer.
- Check that the settings are correct before commissioning for the first time.
- If there are problems with the configuration, contact customer service:
 - When doing so, provide the current configuration file
↪ [Section 7.2.1 "Backup and restore preparation" on page 250](#).
 - Or:
 - Have the pump controller's order number and serial number at hand.
↪ ["Customer service" on page 8](#)

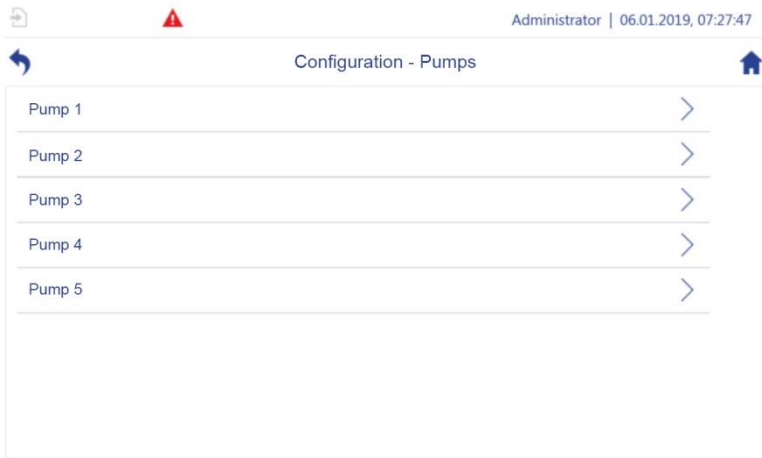
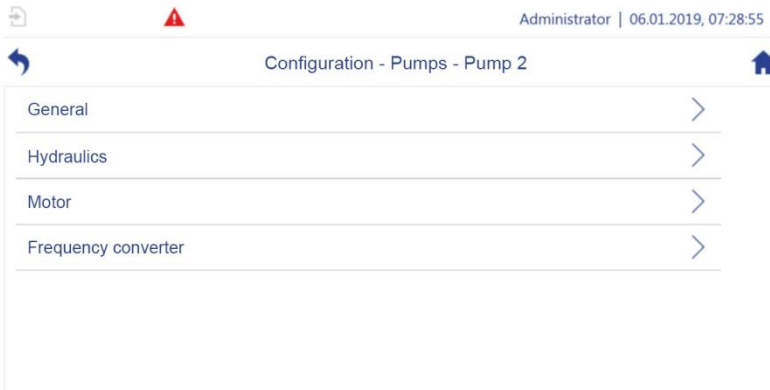

Fig. 107: “Configuration – Pumps”

1. In “Configuration”, tap “Pumps”.
⇒ “Configuration – Pumps” (Fig. 107) opens.
The pumps that are connected are displayed.
2. In “Configuration – Pumps” (Fig. 107), tap the required pump, e.g. “Pump 1”.
⇒ “Configuration – Pumps – Pump 1” (Fig. 108) opens.



Configuration_Pumps_Pump2.png

Fig. 108: “Configuration – Pumps – Pump 2” (example)



The layout of the following screens and submenus is identical for all pumps that are connected.

Most of the menu items are pre-configured by the manufacturer.

General

- In “*Configuration – Pumps – Pump 2*”, tap “*General*”.
⇒ “*Configuration – Pumps – Pump 2 – General*” (Fig. 109) opens.

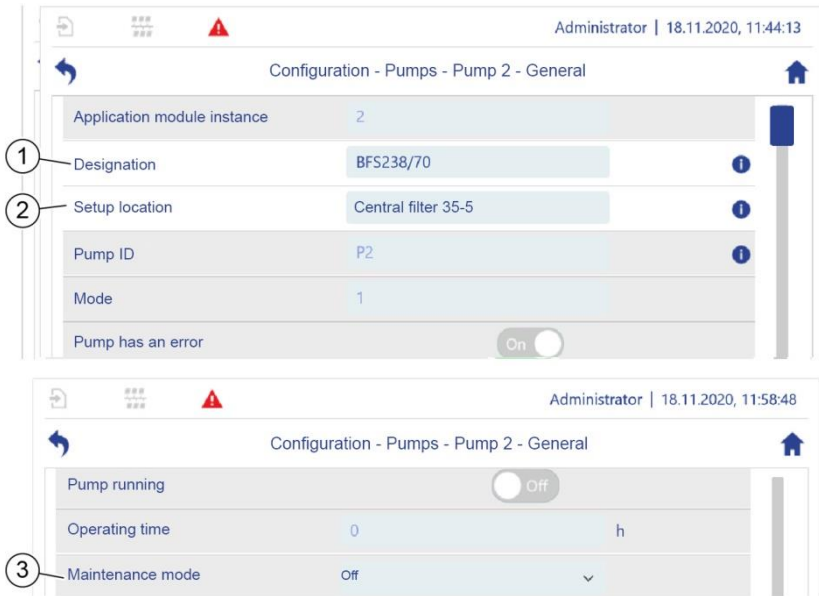

Fig. 109: “*Configuration – Pumps – Pump 2 – General*”

- Enter or change the following parameters:
 - (Pump) designation (Fig. 109/1)
 - Setup location (Fig. 109/2)
 - Maintenance mode (Fig. 109/3)

The remaining parameters are configured by the manufacturer.

- Check that the settings configured by the manufacturer are correct before commissioning for the first time.

Hydraulics

1. In “*Configuration – Pumps – Pump 2*”, tap “*Hydraulics*”.
 ⇒ “*Configuration – Pumps – Pump 2 – Hydraulics*” (Fig. 110) opens.

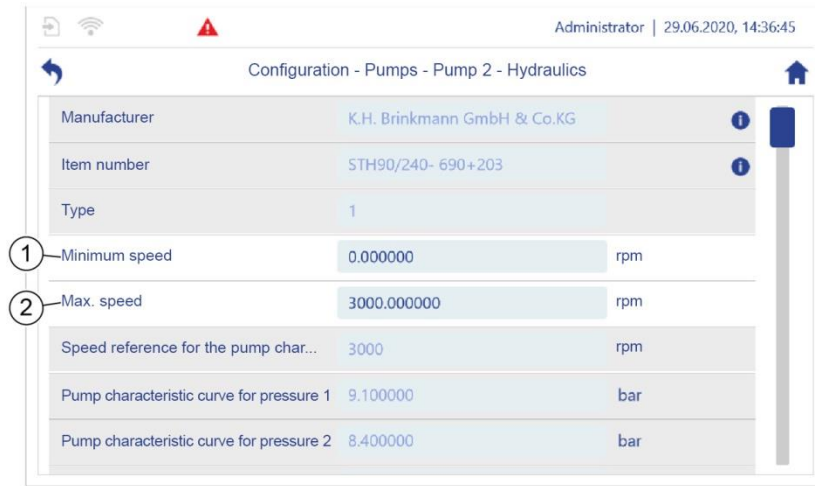

Configuration_Pump_Hydraulics_a-01.png

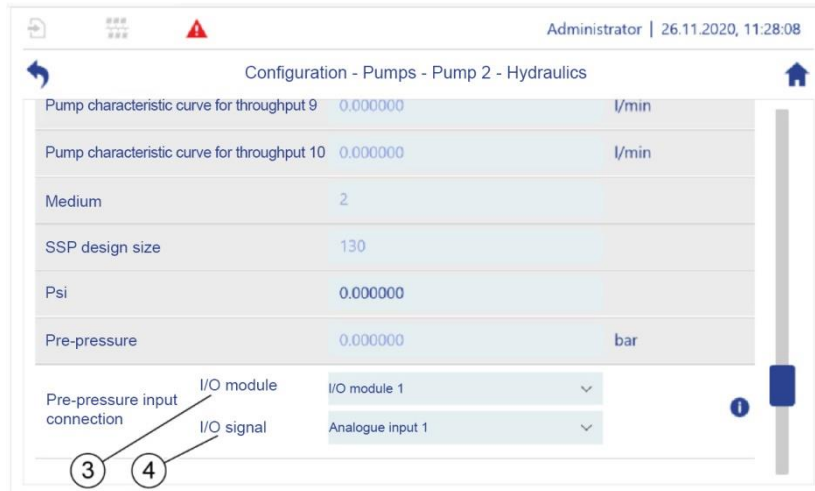

Config_Pumps_Hydraulics.png

Fig. 110: “*Configuration – Pumps – Pump 2 – Hydraulics*”

2. Enter or change the following parameters:
 - Minimum pump speed (Fig. 110/1) ¹⁾
 - Maximum pump speed (Fig. 110/2) ¹⁾
 - If a sensor to measure the pre-pressure is connected:

- The I/O module to which the pressure sensor is connected (Fig. 110/3).
- The input to which the pressure sensor is connected (Fig. 110/4).

The remaining parameters are configured by the manufacturer.

3. Check that the settings configured by the manufacturer are correct before commissioning for the first time.
 4. Scroll to display the supporting points that are used to calculate the pump characteristic curves.
- ¹⁾ The pump controller uses the parameter values for the minimum and maximum pump speed to specify a working range for the pump. If a frequency converter also specifies values for the minimum or maximum pump speed, the frequency converter's values have priority over the pump controller's values.

Motor



All parameters for the pump's motor are pre-set by the manufacturer and cannot be changed. The overview in the “Motor” sub-menu is only for information and to check the parameters. However, you must still use the frequency converter to set parameters for the motor.

- In “*Configuration – Pumps – Pump 1*”, tap “*Motor*”.
 ⇒ “*Configuration – Pumps – Pump 1 – Motor*” (Fig. 111) opens.



Configuration_Pump_Motor_a.png

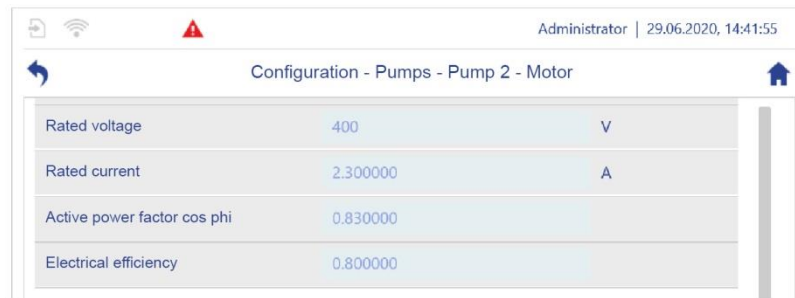

Configuration_Pump_Motor_b.png

Fig. 111: “*Configuration – Pumps – Pump 1 – Motor*”

- Check that the settings are correct before commissioning for the first time.

Frequency converter

1. In “*Configuration – Pumps – Pump 1*”, tap “*Frequency converter*”.
 ⇒ “*Configuration – Pumps – Pump 1 – Frequency converter*” (Fig. 112) opens.

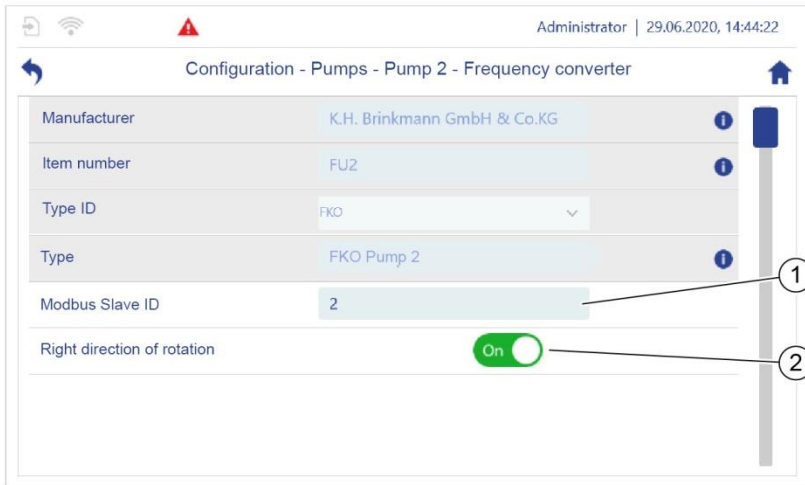

Configuration_Pump_Frequency-converter.png

Fig. 112: “*Configuration – Pumps – Pump 1 – Frequency converter*”

2. Enter or change the following parameters:
 - Direction of rotation
 - Modbus slave ID
 The remaining parameters are configured by the manufacturer.
3. Check that the settings configured by the manufacturer are correct before commissioning for the first time.
4. Perform the corresponding checks and settings for the remaining available pumps.



- The remaining settings are pre-configured by the manufacturer.
- Check that the settings are correct before commissioning for the first time.
- If there are problems with the configuration, contact customer service:
 - When doing so, provide the current configuration file
↳ *Section 7.2.1 “Backup and restore preparation” on page 250.*
 - Or:
 - Have the pump controller’s order number and serial number at hand.
↳ *“Customer service” on page 8*

5.6.2 System settings

Open **“Configuration – System”**

1. Tap  in the navigation bar.
⇒ The **“Configuration”** (Fig. 113) menu opens.

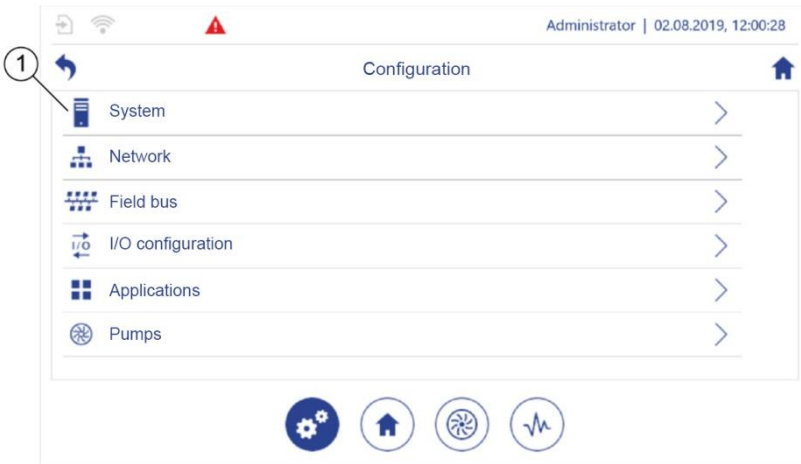

Configuration_menu-01.png

Fig. 113: **“Configuration”**

2. Tap “System” (Fig. 113/1).

⇒ “Configuration – System” (Fig. 114) opens.



Fig. 114: “Configuration – System”

3. For information on the possible settings, see:

- ↪ Section 5.6.2.1 “Screen display options” on page 192
- ↪ Section 5.6.2.2 “Switching logging on” on page 194
- ↪ Section 5.6.2.3 “Converting physical units” on page 195
- ↪ Section 5.6.2.4 “Setting the date and time” on page 196
- ↪ Section 5.6.2.5 “User administration” on page 197
- ↪ Section 5.6.2.6 “Backup and restore” on page 198
- ↪ Section 5.6.2.7 “Device restart” on page 201

4. Use ↩ or 🏠 to exit the screen.

5.6.2.1 Screen display options

Setting display options

You can use the “*Configuration – System – General*” menu to set various display options (Fig. 115).

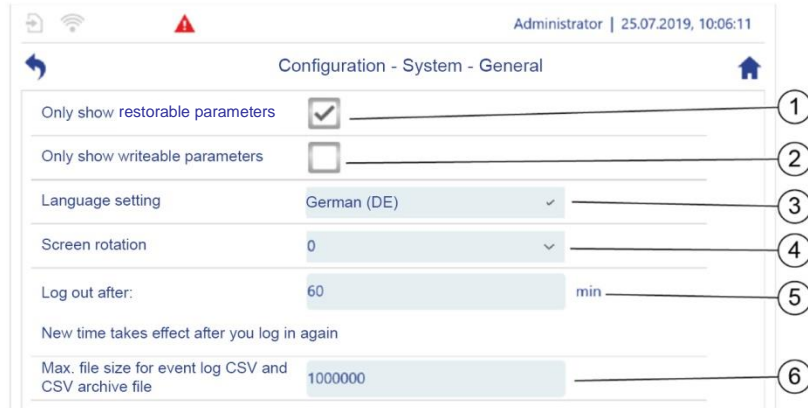

Fig. 115: “*Configuration – System – General*”

- | | | | |
|---|-------------------------------------------------------|---|---------------------------------------------------------------------------------------|
| 1 | Hides all parameters except for restorable parameters | 4 | Defines the number of degrees by which the display is rotated |
| 2 | Hides all parameters except for writeable parameters | 5 | Defines the number of minutes after which the user is logged out automatically |
| 3 | Sets the required system language | 6 | Defines the maximum size in bytes for the event log CSV file and the CSV archive file |

Setting screen rotation

You can use the “Screen rotation” option to rotate the display in 90° steps. You can therefore ensure that the pump controller’s display can be read easily in the selected installation position. The 0° and 180° positions are suitable for installation in a horizontal position. The 90° and 270° options are suitable for installation in a vertical position.

Fig. 116 shows an example of the display in horizontal and vertical rotation.

1. Open the “Configuration – System – General” menu.

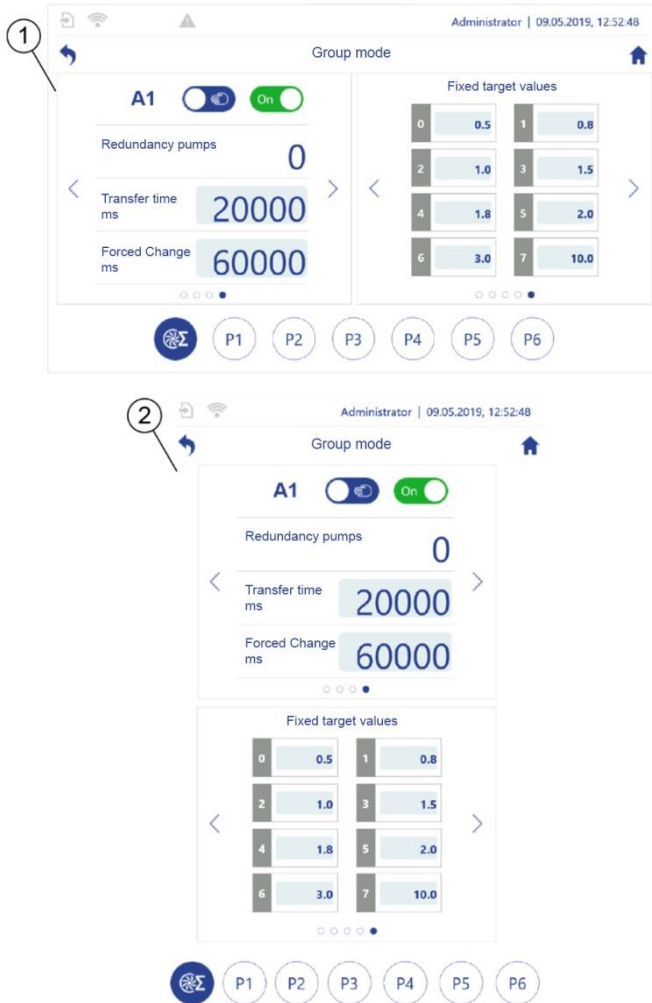

Horizontal_screen_rotation_80-01.png

Vertical_screen_rotation_80-01.png

Fig. 116: Screen rotation (example)

- 1 Horizontal (0°, 180°)
- 2 Vertical (90°, 270°)

2. Set the screen rotation in degrees.
3. Restart the device so that the changes take effect (↳ *section 5.6.2.7 “Device restart” on page 201*).



To adjust the screen brightness, call the “Quick access” dialogue.

↳ *Section 5.2.6 “Dialogue: “Quick access”” on page 68*

5.6.2.2 Switching logging on

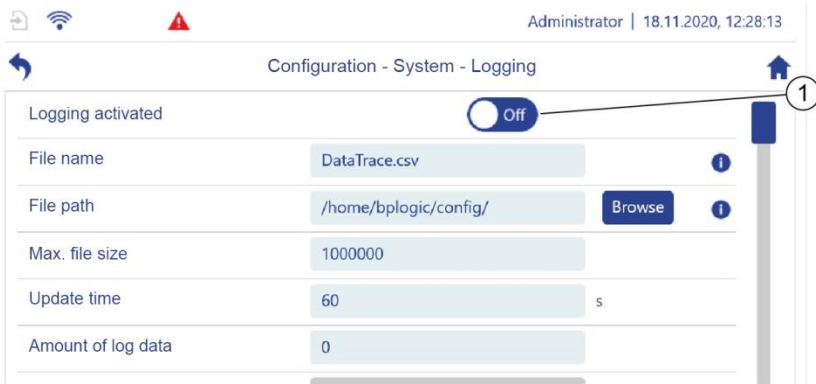

Fig. 117: “Logging”

1. Switching logging on:
 - ↳ *Section 5.2.6 “Dialogue: “Quick access”” on page 68*Or:
 - In “*Configuration – System*”, tap “*Logging*”.⇒ “*Configuration – System – Logging*” opens (Fig. 117).
2. Switch “*Logging*” on (Fig. 117/1).



For information regarding the further settings and options

↳ *section 6.1 “Using logging” on page 240*.

3. Use  or  to exit the screen.

5.6.2.3 Converting physical units

In the “*Unit change*” menu, you can select the physical units in which the pump controller displays the measured process values. For example, you can choose between the units of “Pressure” in bar, Pascal, psi and mWS.

- In “*Configuration – System*“, tap “*Unit change*”.
⇒ “*Configuration – System – Unit change*” (Fig. 118) opens.

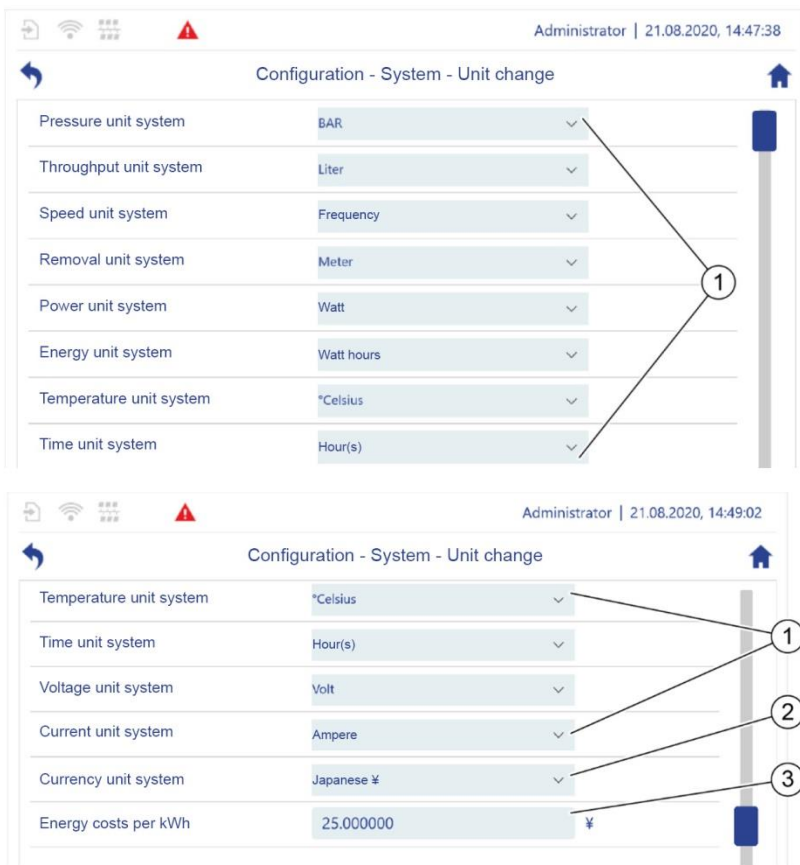

Configuration_System_Unit-change.png

Configuration_System_Unit-change_02.png

Fig. 118: “Unit change”

2. Select the required units (Fig. 118/1).
3. Select the required currency (Fig. 118/2).
4. Enter energy costs (Fig. 118/3).
5. Use ↶ or 🏠 to exit the screen.

5.6.2.4 Setting the date and time

The pump controller has an internal clock that can be set manually or adopt the time from an NTP server. If there is a power interruption, the pump controller can run the clock for up to 30 days using an internal energy buffer.

1. In “*Configuration – System*”, tap “*Date & time*”.
 ⇒ “*Configuration – System – Date & time*” (Fig. 119) opens.

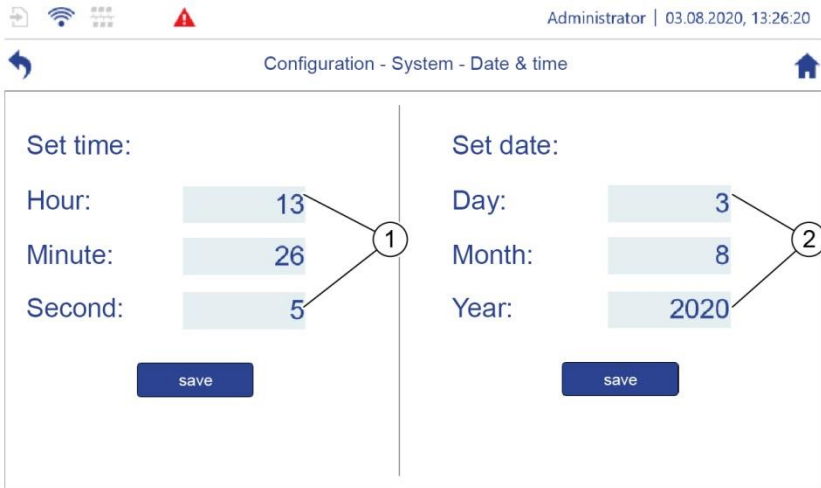

Configuration_System_Date_Time.png

Fig. 119: “Date & time”

2. Set the hours, minutes and seconds (Fig. 119/1).
3. Use “Save” to save the settings.
4. Set the day, month and year (Fig. 119/2).
5. Use “Save” to save the settings.
6. Use ↶ or 🏠 to exit the screen.



To set the time and date automatically ↪ *section 6.3 “Automatic time setting” on page 246.*

5.6.2.5 User administration



Fig. 120: “Configuration – System – User administration”

1. In “Configuration – System”, tap “User administration”.
 - ⇒ “Configuration – System – User administration” (Fig. 120) opens.
2. Tap “Change password” (Fig. 120/1).
 - ⇒ “Configuration – System – User administration – Change password” (Fig. 121) opens.

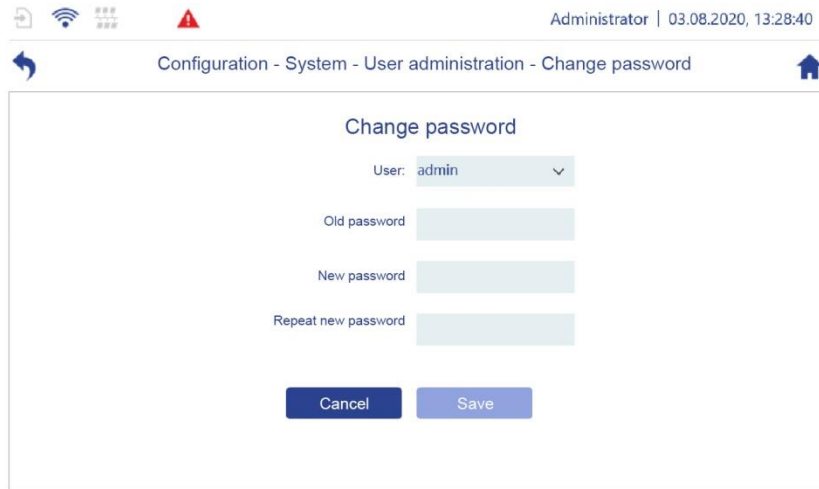



Fig. 121: “Change password”

1. Change the password.
2. Use  or  to exit the screen.

5.6.2.6 Backup and restore

You can use the “*Backup and Restore*” menu to back up all setting parameters, the application software or the entire system software, e.g. on an external storage device. You can use this to restore the backed up data at a later time.

You can back up the following system components:

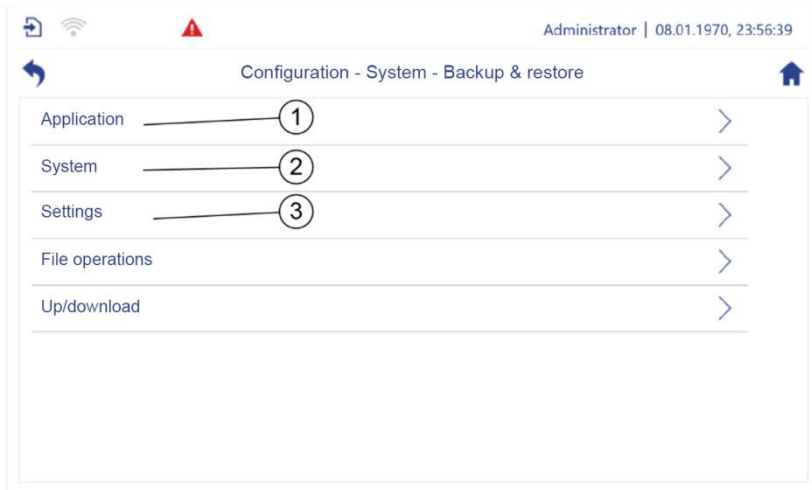

Designation	Description
“ <i>Applications</i> ” (Fig. 122/1)	Backs up the application software but not the setting parameters
“ <i>System</i> ” (Fig. 122/2)	Backs up the system software completely including the available application functions, all setting parameters and the operating system. A complete system clone is created.
“ <i>Settings</i> ” (Fig. 122/3)	Backs up all setting parameters but not the application software

1. In “*Configuration – System*”, tap “*Backup & Restore*”.
 ⇒ “*Configuration – System – Backup & restore*” (Fig. 122) opens.



System_Backup-and-Restore_02.PNG

Fig. 122: "Backup & Restore"

- ↪ Section 7.2.3 "Backing up and updating the system software" on page 254
 - ↪ Section 7.2.1 "Backup and restore preparation" on page 250
 - ↪ "File operations" on page 200
2. Use  or  to exit the screen.

File operations

1. In “*Configuration – System – Backup & Restore*”, tap “*File operations*”.
⇒ “*Configuration – System – Backup & restore – File operations*” (Fig. 122) opens.

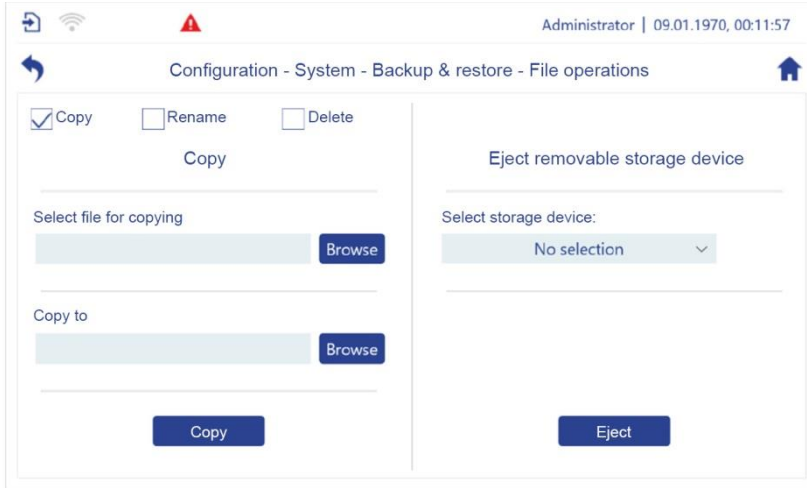

Config_System_File-operations.png

Fig. 123: “*File operations*”

2. In the top screen area, select:
 - Copy
 - Rename
 - Delete



For information regarding the “*Browse*” function, also see [↪ section 5.2.10 “File manager” on page 81.](#)

Copy file

1. Use “*Browse*” to select the required file.
2. Use “*Browse*” to select the new storage location for the file.
3. Use “*Copy*” to start copying.

Rename file

1. Use “*Browse*” to select the required file.
2. Enter the new file name.
3. Use “*Rename*” to start renaming.

Delete file

1. Use “*Browse*” to select the required file.
2. Use “*Delete*” to start deleting.
3. Use  to exit the screen.



To use storage devices

↳ *Section 5.6.7.2 “Connecting storage media” on page 222.*

↳ *Section 5.7.2 “Ejecting the removable storage device safely” on page 225*

5.6.2.7 Device restart

You must always restart the device after you have loaded a new configuration file. The new configuration's settings only take effect after the restart.

1. In “*Configuration – System*”, tap “*Device restart*”.
 - ⇒ “*Configuration – System – Device restart*” (Fig. 124) opens.

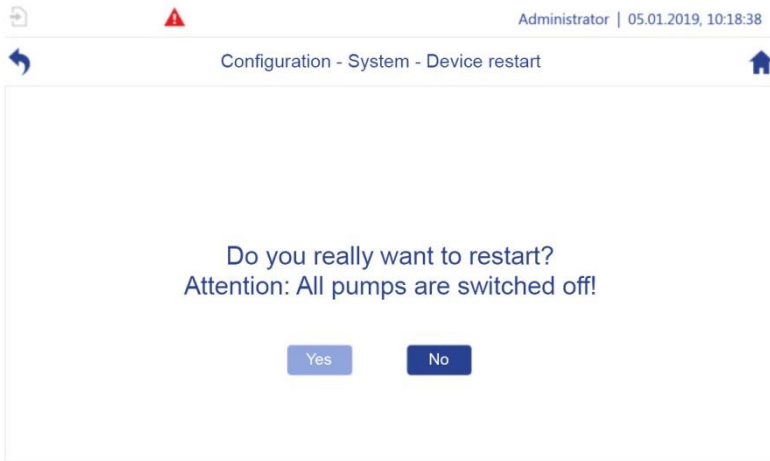

Fig. 124: "Device restart"

2. Press "Yes" to confirm the device restart.
3. If you do not want to perform a restart, use "NO", ↶ or 🏠 to exit the screen.

5.6.3 Setting LAN parameters

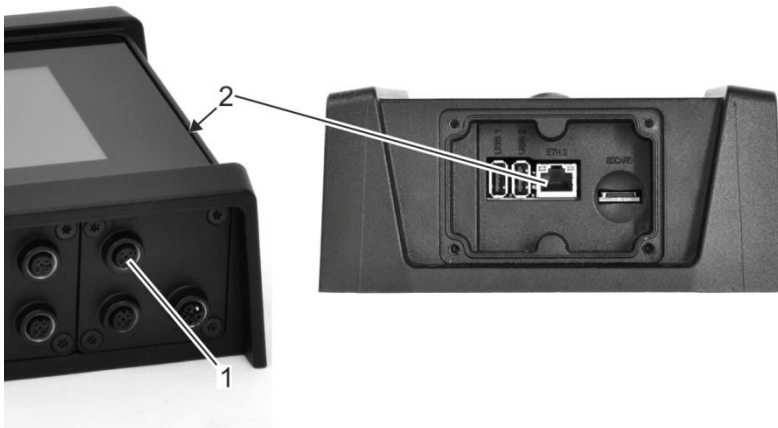

Fig. 125: Ethernet connections

1. Connecting the ethernet properly:
 - ETH 1 in slot C (Fig. 125/1, M12 connection)
 - ETH 2 in the service access (Fig. 125/2, RJ45 connection)



The ETH-2 connection in the service access is used for temporary access for service and maintenance purposes. As long as the cover on the service access is open, housing protection category IP65 is removed.

2. In “*Configuration*”, tap “*Network*”.
 - ⇒ “*Configuration – Network*” (Fig. 126) opens.

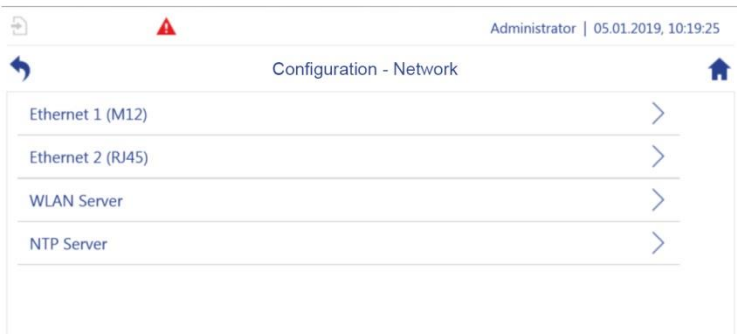
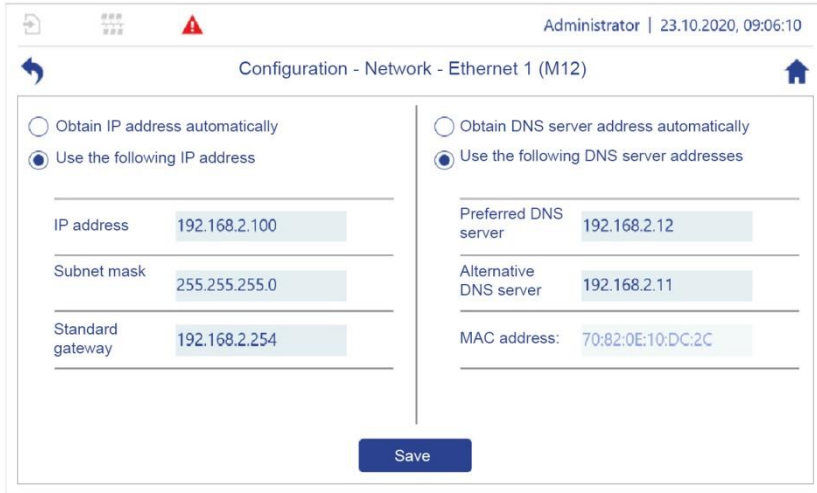

Fig. 126: “*Configuration – Network*”

3. In “*Configuration – Network*”, select the required connection by tapping:
 - Ethernet 1 (M12)
 - Ethernet 2 (RJ45)
 - ⇒ “*Configuration – Network – Ethernet 1 (M12)/Ethernet 2 (RJ45)*” (Fig. 127) opens.



Configuration_Ethernet1.png

Fig. 127: “Configuration – Network – Ethernet 1 (M12)/Ethernet 2 (RJ45)”



Fig. 127 and the configuration options are identical for Ethernet 1 and 2.

4. Select the required options depending on the server used:
 - If you use a DHCP server:
 - Tap “Obtain IP address automatically”.
 - ⇒ The IP address assigned by the DHCP server is displayed in the IP address field.
 - Tap “Obtain DNS server address automatically”.
 - If you are not using a DHCP server:
 - Tap “Use the following IP address” and enter the IP address.
 - Tap “Use the following DNS server addresses” and enter the DNS server addresses.
5. Press “Save” to confirm the selection.

5.6.4 Setting WLAN module parameters

Materials:

- USB WLAN dongle

Opening the service access

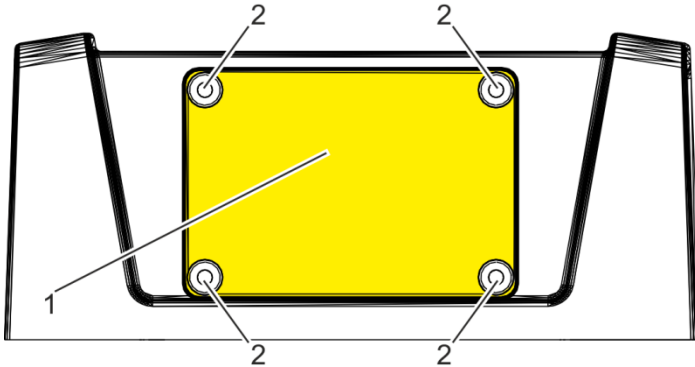

Fig. 128: Expose service access

1. Undo the screws (Fig. 128/2).
2. Remove the plastic cover (Fig. 128/1).

Plugging the dongle in

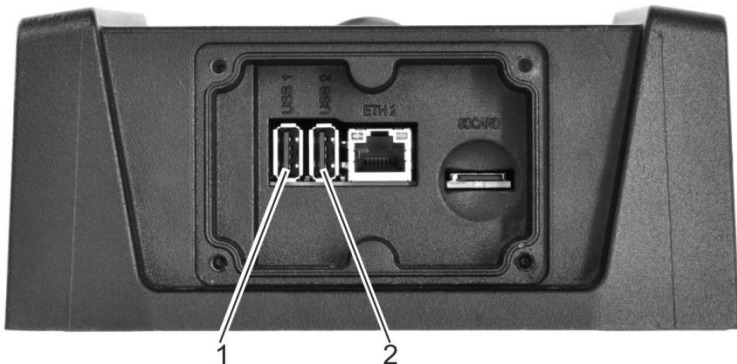

Fig. 129: USB connections

3. Insert the USB WLAN dongle into one of the USB connections (Fig. 129/1 + 2).
Note the following:

- EDIMAX EW-7811Un dongles or comparable products with a Realtek RTL8188CUS chip set are specified
- The dongle may protrude by a maximum of 1.5 cm so that the service access can be closed.
- Metallic covers can have a shielding effect.

Closing the service access

4. Use the plastic cover to close the service access (Fig. 128/1).



Loss of protection category when the service access is open!

The pump controller only has protection class IP65 when the service access cover is on.

5. Screw the plastic cover on.

Setting WLAN parameters

6. In “*Configuration*”, tap “*Network*”.
⇒ “*Configuration – Network*” (Fig. 130) opens.

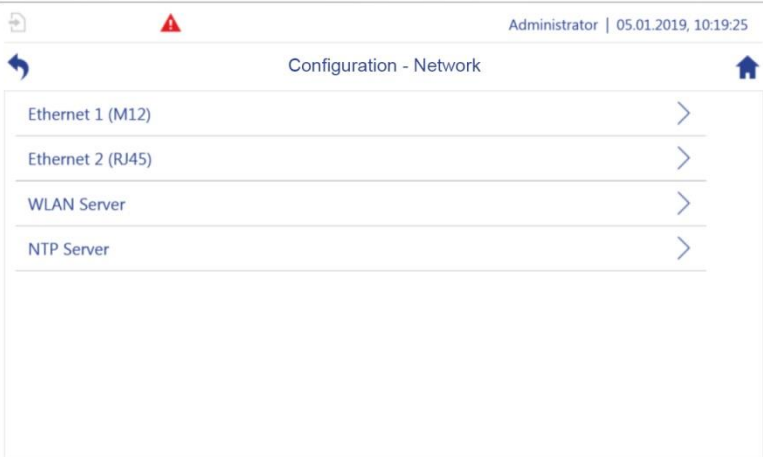

Fig. 130: “*Configuration – Network*”

7. In “*Configuration – Network*”, tap “*WLAN*”.
⇒ “*Configuration – Network – WLAN Server*” (Fig. 127) opens.

Administrator | 03.08.2020, 13:33:13

Configuration - Network - WLAN server

Projected On

Active On

IP address 192.168.3.100

Subnet mask 255.255.255.0

WLAN SSID BP Logic

WLAN channel 6

Password 11111111

Web visualisation

Save

Configuration_System_WLAN_Server.png

Fig. 131: "WLAN Server"

8. In "Configuration – Network – WLAN Server", make the following settings:
 - Projected: "On" if a working WLAN dongle was inserted.
 - Active: "On" to switch on the WLAN function.
 - Enter the IP address.
 - Enter the subnet mask.
 - Enter the WLAN access data:
 - WLAN SSID
 - WLAN channel
 - Password (at least 8 characters)
9. If required: If the pump controller is to be operated via remote access using a web browser, scan the QR code so that the start screen's URL is opened directly in the web browser.

5.6.5 Checking field bus parameters

The pump controller is equipped with pre-configured, modified field buses. These field buses are used for communication between the pump controller and further system components such as the controller on a machine tool.

5.6.5.1 Displaying the field bus type

The field bus type that is available on your pump controller depends on your configuration. The field bus on your pump controller is pre-configured by the manufacturer according to your configuration. Only the manufacturer can set the field bus type that is available on your pump controller.

You can use the pump controller to display the field bus that is available.



- The settings are pre-configured by the manufacturer.
- Check that the settings are correct before commissioning for the first time.
- If there are problems with the configuration, contact customer service:
 - When doing so, provide the current configuration file
↳ *Section 7.2.1 “Backup and restore preparation” on page 250.*
 - Or:
 - Have the pump controller’s order number and serial number at hand.
↳ *“Customer service” on page 8*

1. In *“Configuration”*, tap *“Field bus”*.
⇒ *“Configuration – Field bus”* (Fig. 132) opens.



Configuration_Field-bus_1e-01.png

Fig. 132: "Configuration – Field bus"

2. Tap "General" (Fig. 132/1).

⇒ "Configuration – Field bus – General" (Fig. 133) opens.

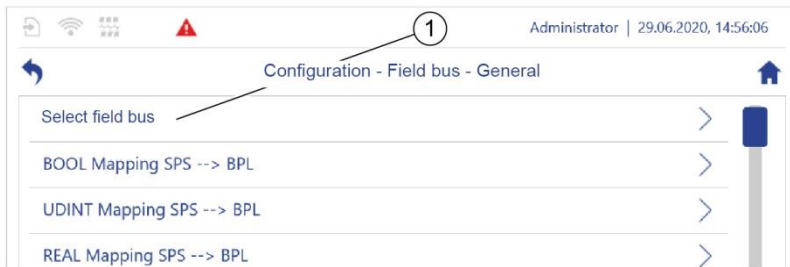

Config_Field-bus_General_1e-01.png

Fig. 133: "Configuration – Field bus – General"

3. Tap "Select Field bus" (Fig. 133/1).

⇒ "Configuration – Field bus – General – Select field bus" (Fig. 134) opens.

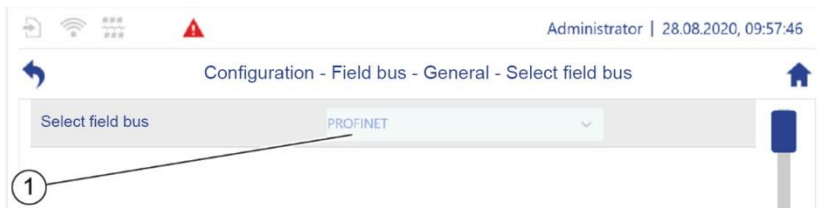

Configuration_Field-bus-selection.png

Fig. 134: "Configuration – Field bus – General – Select field bus"

4. Check whether the correct field bus type is set (Fig. 134/1).

5. If the correct field bus type is not set, contact customer service.

5.6.5.2 Checking the Modbus RTU parameters

The Modbus RTU is a field bus that enables communication between the pump controller and the frequency converter for a pump.

The devices can only communicate with each other if the parameter values for parity, stop bits and baud rate that are set on the pump controller match the parameter values that are set on the frequency converter. Therefore, the parameter values must be checked before commissioning the pump controller.



- The settings are pre-configured by the manufacturer.
- Check that the settings are correct before commissioning for the first time.
- If there are problems with the configuration, contact customer service:
 - When doing so, provide the current configuration file
 - ↳ *Section 7.2.1 “Backup and restore preparation” on page 250.*
 - Or:
 - Have the pump controller’s order number and serial number at hand.
 - ↳ *“Customer service” on page 8*

1. In “*Configuration*”, tap “*Field bus*”.

⇒ “*Configuration – Field bus*” (Fig. 135) opens.



Fig. 135: “*Configuration – Field bus*”

2. Tap “*Modbus RTU*” (Fig. 135/1).

⇒ “*Configuration – Field bus – Modbus RTU*” (Fig. 136) opens.



Configuration_Param_Register

Fig. 136: Modbus RTU

3. Tap “Communication parameters”(Fig. 136/1).
 - ⇒ “Configuration – Field bus – Modbus RTU– Communication parameters” (Fig. 137) opens.

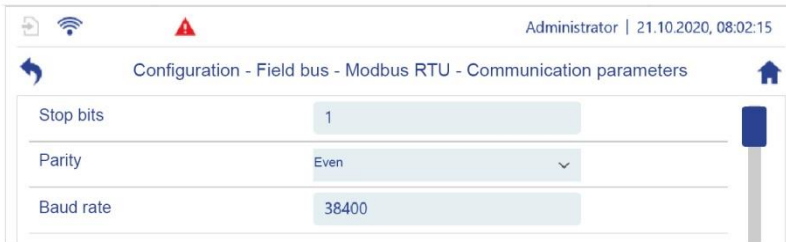

Config_Modbus_Communication_parameters-01.png

Fig. 137: Modbus RTU

4. Check whether the parameter values that are displayed for stop bits, parity and baud rate (Fig. 137) match the parameter values that are set on the frequency converter.
5. If the parameter values that are set on the pump controller do not match the parameter values that are set on the frequency converter, contact customer service.

5.6.6 Using the PROFINET IO field bus or the EtherNet/IP field bus

PROFINET IO field bus

The pump controller comprises a PROFINET IO Device option.

PROFINET IO is an Ethernet-based field bus to network decentralised automation components such as sensors, actuators, drives and pumps.

You can use the PROFINET IO field bus to connect the pump controller to a PROFINET IO field bus system in order to exchange process values with a machine controller. The pump controller acts as a PROFINET IO device.

EtherNet/IP field bus

The pump controller comprises an EtherNet/IP Adapter option.

EtherNet/IP is an Ethernet-based field bus to transfer process data. You can use the EtherNet/IP field bus to connect the pump controller to an EtherNet/IP network in order to exchange process values with a machine controller. The pump controller acts as an EtherNet/IP adapter.

5.6.6.1 Communication with the machine controller

The pump controller can exchange process values in data containers with the data types BOOL, UDINT and REAL with the machine controller. The data containers are divided into 14 modules. Each of these modules uses one slot on the pump controller.

In order to enable the pump controller and the machine controller to exchange process values with each other, you must transfer the assignments of the modules to the slots 1:1 to the machine controller. The information required for this is stored in the pump controller's device description.

- If you use a PROFINET field bus, the device description is stored in the "PROFINET GSD" file (general station description) on the pump controller.
- If you use an EtherNet/IP field bus, the device description is stored in the "EnipAdapter.EDS" file (electronic data sheet) on the pump controller.

5.6.6.2 Setting the PROFINET IO field bus or the EtherNet/IP field bus parameters

In the 6 submenus below "*Field bus – General*", define the parameters for which the pump controller will exchange values with the machine controller. To do this, assign the required parameters to data containers.

The parameter list marks all parameters that you can select using the 6 submenus.

Submenu	Description
BOOL mapping PLC → BPL	Defines up to 32 parameters for which values are sent in BOOL data containers ¹⁾ from the machine controller to the pump controller
UDINT mapping PLC → BPL	Defines up to 8 parameters for which values are sent in UDINT data containers ¹⁾ from the machine controller to the pump controller
REAL mapping PLC → BPL	Defines up to 16 parameters for which values are sent in REAL data containers ¹⁾ from the machine controller to the pump controller.
BOOL mapping BPL → PLC	Defines up to 32 parameters for which values are sent in BOOL data containers ¹⁾ from the pump controller to the machine controller
UDINT mapping BPL → PLC	Defines up to 8 parameters for which values are sent in UDINT data containers ¹⁾ from the pump controller to the machine controller
REAL mapping BPL → BPL	Defines up to 16 parameters for which values are sent in REAL data containers ¹⁾ from the pump controller to the machine controller

¹⁾ One data container contains one parameter value.

The various data containers are suitable for different signals:

- The BOOL data type is a binary signal. A binary signal can only express two states, e.g. “on” and “off”, or “present” and “not present”. Data containers with the BOOL data type are therefore suitable for transferring limit switch signals, e.g. to indicate operational readiness for an application module.
- A data container with the UDINT data type can contain any natural number without a mathematical sign. Data types with the UDINT data type are therefore suitable for transferring analog signals, e.g. to specify target values.

- A data container with the REAL data type can contain any floating-point number. Data containers with the REAL data type are therefore suitable for transferring analog signals, e.g. to specify target values.
1. Tap  in the navigation bar.
 - ⇒ The “Configuration” menu opens.
 2. In the “Configuration” menu, tap “Field bus”.
 - ⇒ “Configuration – Field bus” opens.
 3. In “Field bus”, tap “General”.
 - ⇒ “Configuration – Field bus – General” (Fig. 138) opens.

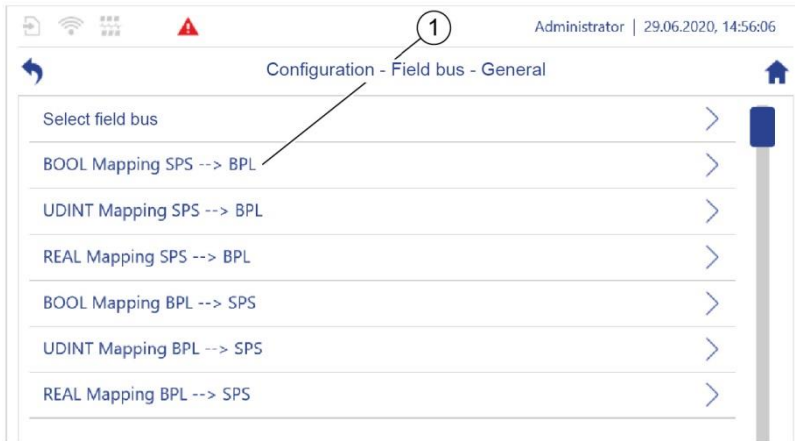

Config_Field-bus_General.png

Fig. 138: “General”

4. Tap the required submenu, e.g. “BOOL Output Mapping” (Fig. 138/1).
 - ⇒ “BOOL Output Mapping” opens.
5. Make the required parameter settings.

Checking that the set parameters are correct

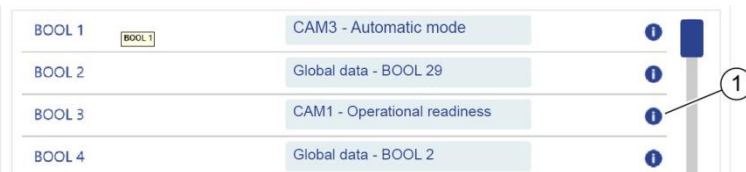

Config_Boo_Boo_Output.png

Fig. 139: Checking the set parameters

1. Tap  next to an input field (Fig. 139/1).
 - ⇒ The complete path for the parameter set is displayed.
2. Check that the set parameters are correct.

5.6.6.3 Activating and connecting the PROFINET IO field bus or the EtherNet/IP field bus

Activating the PROFINET IO field bus or the EtherNet/IP field bus

You must activate the corresponding pump controller field bus in order that the pump controller can connect to a PROFINET IO field bus system or to an EtherNet/IP network.

The two field bus types are activated in the same way.

1. Tap  in the navigation bar.
 - ⇒ The “Configuration” menu opens.
2. In the “Configuration” menu, tap “Field bus”.
 - ⇒ “Configuration – Field bus” opens.
3. In “Field bus”, tap the required field bus, e.g. “PROFINET”.
 - ⇒ “Configuration – Field bus – PROFINET” (Fig. 140) opens.



Config_Field-bus_PROFINET-01.png

Fig. 140: “PROFINET”

4. Set the software switch to “On” (Fig. 140/1).
 - ⇒ The required field bus is activated.

Connecting the pump controller and the machine controller

In order to be able to transfer the pump controller’s machine description to a machine controller, you must first download the machine description from the pump controller.



- For information regarding downloading files, see ↗ 5.6.7 “Exchanging data” on page 219.
- When transferring the device description and assigning the modules, observe the manual for the machine controller.
-

1. If you are using a PROFINET field bus, proceed as follows:
 - Download the “*PROFINET GSD*” file from the “*/home/bplogic*” directory on the pump controller.
 - Install the “*PROFINET GSD*” file on the machine controller.
2. If you are using an EtherNet/IP field bus, proceed as follows:
 - Download the “*EnipAdapter.EDS*” file from the “*/home/bplogic*” directory on the pump controller.
 - Install the “*EnipAdapter.EDS*” file on the machine controller.
3. Select the pump controller in the machine controller’s development environment and connect it to the machine controller.
4. Configure the assignment of modules to slots 1 - 14 on the machine controller as shown:



The assignment of modules to slots 1 - 14 on the machine controller must correspond 1:1 to slots 1 - 14 on the pump controller. This is the only way in which the pump controller can exchange process values with the machine controller.

Slot	Module
1	Input 8Bit_1 ¹⁾
2	Input 8Bit_2 ¹⁾
3	Input 8Bit_3 ¹⁾
4	Input 8Bit_4 ¹⁾

Slot	Module
5	Input Unsigned32*8_1 ²⁾

- ¹⁾ includes 8 containers for exchanging boolean variables between the machine controller and the pump controller.
- ²⁾ includes 8 containers for exchanging 32-bit variables without a mathematical sign for natural numbers between the machine controller and the pump controller.

Slot	Module
6	Input Float32*8_1 ³⁾
7	Input Float32*8_2 ³⁾
8	Output 8Bit_1 ¹⁾
9	Output 8Bit_2 ¹⁾
10	Output 8Bit_3 ¹⁾
11	Output 8Bit_4 ¹⁾
12	Output Unsigned32*8_1 ²⁾
13	Output Float32*8_1 ³⁾
14	Output Float32*8_2 ³⁾

- ¹⁾ includes 8 containers for exchanging boolean variables between the machine controller and the pump controller.
- ²⁾ includes 8 containers for exchanging 32-bit variables without a mathematical sign for natural numbers between the machine controller and the pump controller.
- ³⁾ includes 8 containers for exchanging 32-bit variables for floating-point numbers between the machine controller and the pump controller.
- 5.** Check whether the assignment of modules to the slots on the machine controller corresponds to the assignment on the pump controller.
- ⇒ The pump controller and the machine controller can exchange process values with each other.

5.6.7 Exchanging data

You can exchange data between the pump controller and other devices in two ways:

- Exchanging the data directly with a networked PC (↪ *section 5.6.7.1 “Uploading and downloading files” on page 219*)
- Storing the files intermediately on a storage medium (↪ *section 5.6.7.2 “Connecting storage media” on page 222*)

5.6.7.1 Uploading and downloading files

Use the “*Up/Download*” menu to exchange data between the pump controller and a networked PC.



In order to be able to exchange files with the pump controller, you must network your PC to the pump controller.

- ↪ Section 5.6.3 “Setting LAN parameters” *on page 202*.
- ↪ Section 5.6.4 “Setting WLAN module parameters” *on page 205*.

The “*Up/Download*” menu cannot be used on the pump controller itself, but only via a web browser.

- Use the web browser on the networked PC to log in to the pump controller.
- ↪ “Configuring the network settings” *on page 55*.

Downloading files from the pump controller

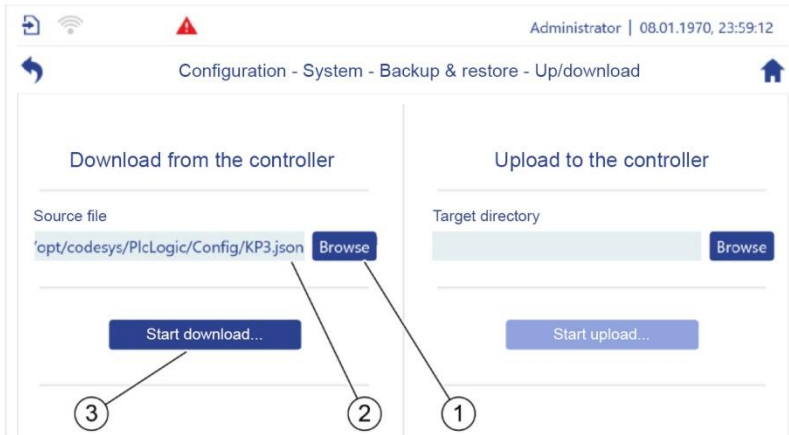

Menu_Up-Download_Download-01.png

Fig. 141: "Up/Download"

1. Tap in "Configuration" – "System" – "Backup & Restore" – "Up/Download".
⇒ "Up/Download" (Fig. 141) opens.
2. Tap the "Browse" button (Fig. 141/1).
⇒ The file manager opens.
3. Select a file for download and confirm the selection.
⇒ The selected file's complete path is displayed (Fig. 141/2).
4. Tap the "Start download..." button (Fig. 141/3).
⇒ The download starts.
5. Follow the download instructions in your web browser.
⇒ The subsequent procedure depends on your web browser.
⇒ The "Up/Download" menu confirms the successful download (Fig. 142).



Download_finished-01.png

Fig. 142: successful download

Uploading files to the pump controller

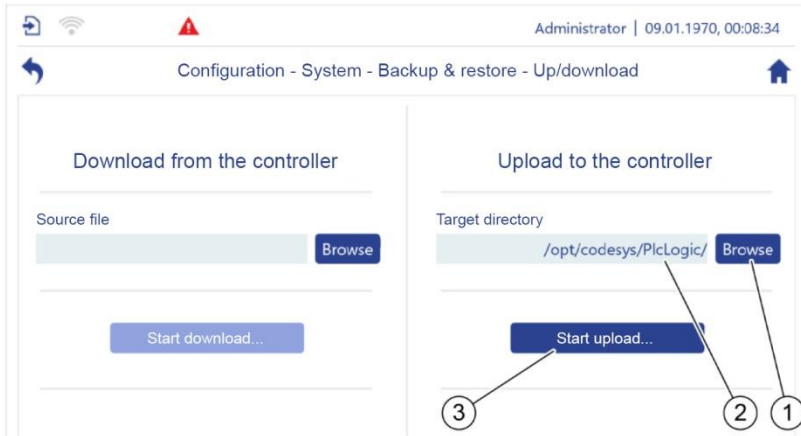

Fig. 143: "Up/Download"

1. Tap in "Configuration" – "System" – "Backup & Restore" – "Up/Download".
⇒ "Up/Download" (Fig. 143) opens.
2. Tap the "Browse" button (Fig. 143/1).
⇒ The file manager opens.
3. Select the target directory into which the file is to be uploaded and confirm the selection.
⇒ The target directory's complete path is displayed (Fig. 143/2).
4. Tap the "Start upload..." button (Fig. 143/3).
⇒ A message in a dialogue box prompts you to select a file. The message's appearance depends on your web browser.
5. Select the file that is to be uploaded to the pump controller and confirm the selection. The required handling steps depend on your web browser.
⇒ The upload starts.
⇒ The menu confirms the successful upload (Fig. 144).

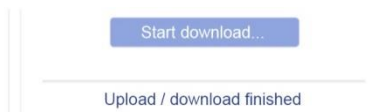

Fig. 144: successful upload

5.6.7.2 Connecting storage media



Storage media

- In addition to micro SD cards, USB storage media can also be used. However, the service access can only be sealed reliably if the height of the USB storage medium is less than 1.5 cm.
- Pre-format the storage media FAT32 for use with the pump controller.

1. Pre-format the storage medium with FAT32.
2. Exposing the service access: ↪ *Section 5.6.4 ‘Setting WLAN module parameters’ on page 205*, handling step 1 and handling step 2.

Inserting storage media

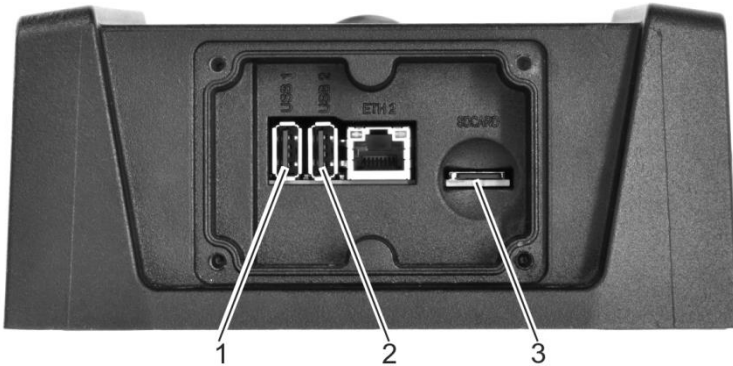

Fig. 145: USB connections, micro SD slot

1. Insert a USB storage medium into one of the USB connections (Fig. 145/1 + 2).

And/or:

Insert the micro SD card into the micro SD slot (Fig. 145/3).

Note the following:

- The USB storage medium may protrude by a maximum of 1.5 cm so that the service access can be closed.
 - Use a micro SD memory card with a maximum capacity of 32 GB.
2. Closing the service access: ↪ *Section 5.6.4 “Setting WLAN module parameters” on page 205*, handling step 4 and handling step 5.

Open the directory path for the storage medium.

A local directory is set up on the pump controller, which you can use to access all connected storage media.

1. Use the file manager to navigate to the following directory path:
/home/bplogic/media
⇒ One directory is displayed for each connected storage medium.
2. Tap the directory for the storage medium that you wish to access.



For further use:

- ↪ *Section 6.1 “Using logging” on page 240*
- ↪ *Section 7.2.3 “Backing up and updating the system software” on page 254*
- ↪ *Section 7.2.2 “Backing up and updating application modules” on page 251*
- ↪ *Section 7.2.4 “Backing up and updating settings” on page 257*

5.7 Operation

5.7.1 Locking and unlocking the screen

Lock screen

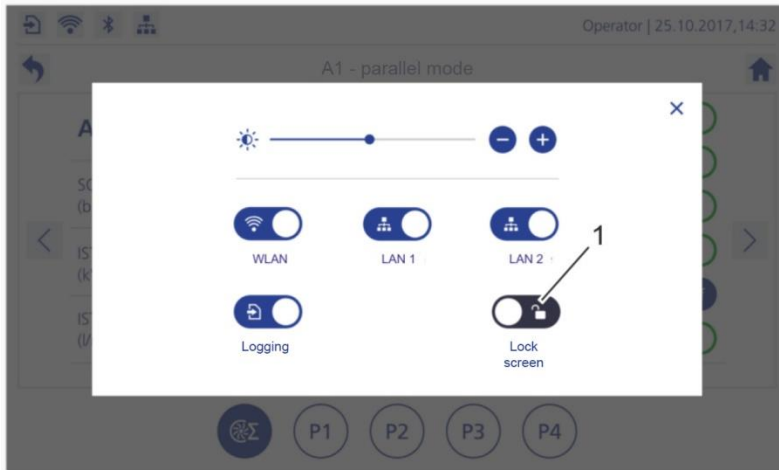

Fig. 146: "Quick access" dialogue

1. Open the "Quick access" dialogue by swiping from top to bottom.
2. Tap "Lock screen" (Fig. 146/1).

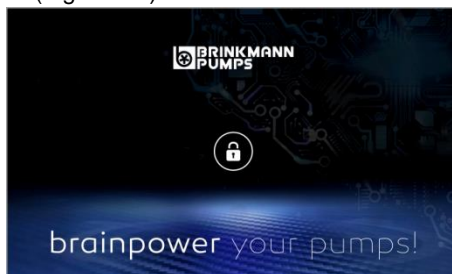

Fig. 147: "Lock screen"

⇒ The screen is locked (Fig. 147).

Unlocking the screen



Fig. 148: “Lock screen”

1. In “Lock screen”, tap the padlock (Fig. 148/1).
⇒ The “Login screen” is displayed.
2. Log in ↪ Section 5.1 ‘Switching on and logging in’ on page 52.

5.7.2 Ejecting the removable storage device safely



NOTICE!

Possible damage to the file system due to ejecting the connected storage device improperly

If you remove a connected storage device improperly, the removable storage device’s file system may get damaged.

- Eject the storage device safely.

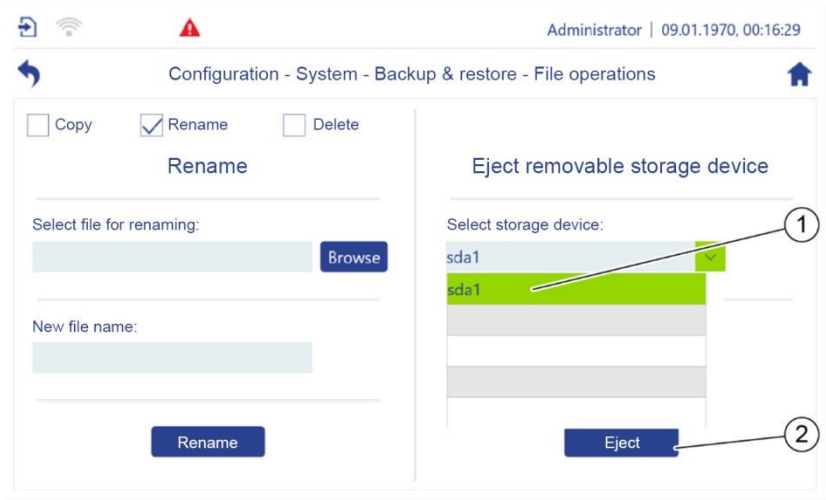

The removable storage device
can now be removed



File-operations_Ejecting_Storage-device.png

Fig. 149: Eject removable storage device

1. In “*Configuration – System – Backup & Restore – File operations*”, tap the storage device to be ejected (Fig. 149/1).
2. Tap “*Eject*” (Fig. 149/2).
3. Press “*OK*” (Fig. 149/3) to confirm ejection.
4. Remove the storage device.

5.7.3 Using the application overview during operation

- Tap  in the navigation bar.
 - ⇒ “Application overview” (Fig. 150) opens.
 - ⇒ All existing application modules are displayed (A1 to A5 in Fig. 150).

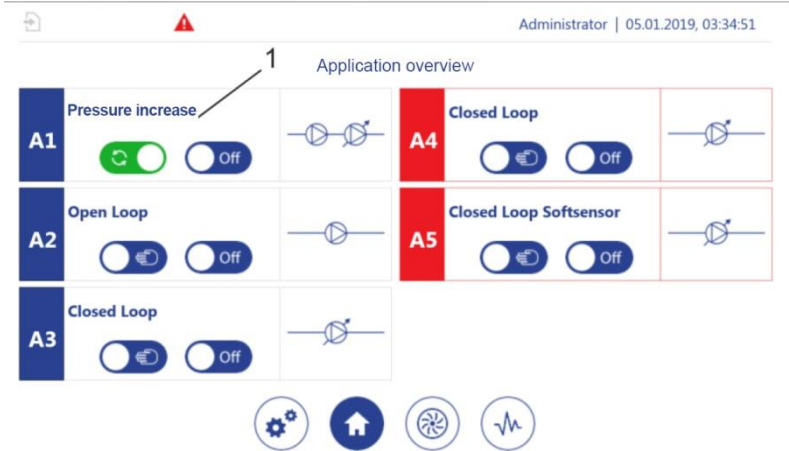

Fig. 150: “Application overview”

- Tap an application (such as pressure increase, Fig. 150/1) to display further settings.
 - ⇒ The application single view for the “Pressure increase” application module (example, Fig. 151/1) opens.

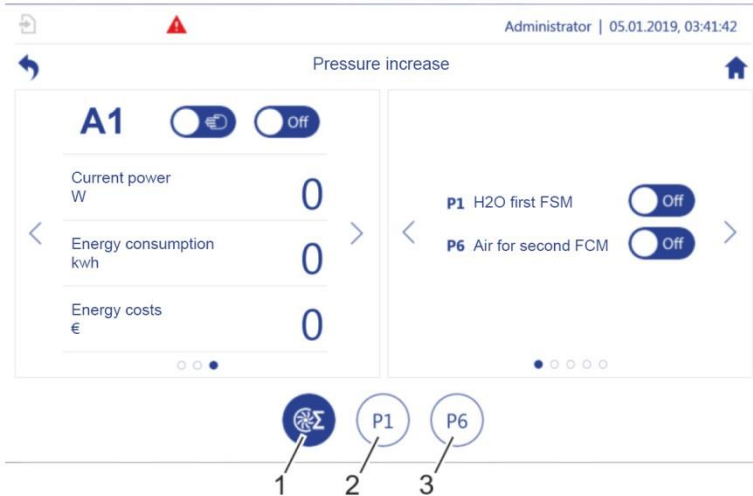

Fig. 151: “Pressure increase”

- 1 Application single view for all connected pumps
- 2 + 3 Single views for the assigned pumps
3. Tap < or > to display further settings (favourites, energy consumption, speed, sensor data, pump characteristic curves, etc.):



The available displays are specific for every application.

For more details, also see:

- ↪ [Section 5.7.4 “Using the pump overview during operation” on page 229](#)
- ↪ [Section 5.3 “Application modules” on page 91](#)
- ↪ [Section 5.3.2 “Displaying parameters as favourites” on page 97](#)
- ↪ [Section 5.6.1.5 “Setting pump parameters” on page 183](#)

4. You can use the jump icons to switch between the application single view (Fig. 151/1) or the single views for the assigned pumps (Fig. 151/2 + 3).

5.7.4 Using the pump overview during operation



Only specialists may adjust control parameters.

1. Tap  in the navigation bar.
 - ⇒
 - “Pump overview” (Fig. 152) opens.
 - All pumps that are present are displayed (Fig. 152/1).
 - In addition, the application modules to which the pumps are assigned are also displayed (Fig. 152/3–4).

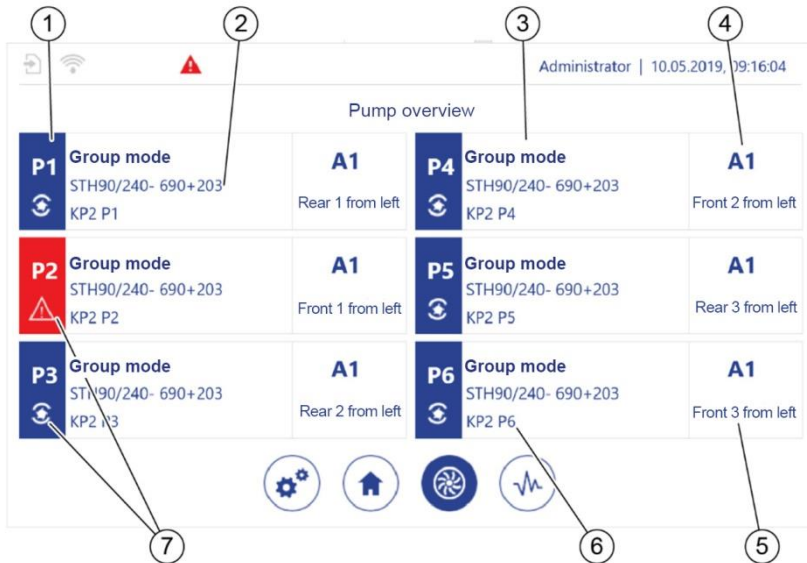



Pump overview_example-01.png

Fig. 152: “Pump overview”

- | | |
|-----------------------------------------------------------------------|------------------------------------------------------------------|
| 1 Pump number | 4 Number of the application module to which the pump is assigned |
| 2 Pump item number | 5 Pump setup location |
| 3 Designation of the application module to which the pump is assigned | 6 Pump designation |

7 Pump status:

- : indicates that the pump is running in normal mode.
- : indicates that the pump is in maintenance mode.
- : indicates that there is a fault on the pump.

2. Tap a pump (such as pressure increase, Fig. 152/1) to display further settings.

⇒ The application single view for the “Pressure increase” application module (example, Fig. 153) opens.



Fig. 153: “Pressure increase”

1 Total parameter for all connected pumps

2 + 3 Single views for the connected pumps

3. Tap < or > to display further settings (energy consumption, speed, sensor data, pump characteristic curves, etc.):



The contents of the application single views are specific for every application.

For more details, also see:

- ↪ *Section 5.7.4 “Using the pump overview during operation” on page 229*
- ↪ *Section 5.3 “Application modules” on page 91*
- ↪ *Section 5.6.1.5 “Setting pump parameters” on page 183*

4. You can use the jump icons to switch between the application single view (Fig. 153/1) or the single views for the assigned pumps (Fig. 153/2 - 3).

Executing the application module in manual mode

Manual mode is used to set up the pump and for troubleshooting.

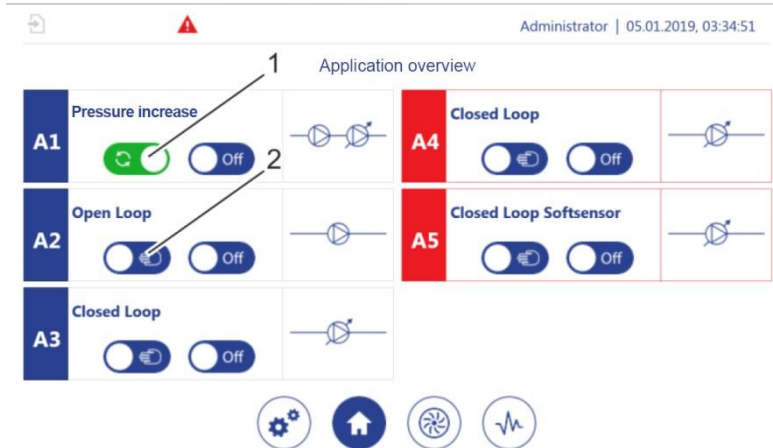

Fig. 154: “Application overview”

- 1 Automatic mode
 - 2 Manual mode
5. In the “Application overview” (↪ *section 5.7.3 “Using the application overview during operation” on page 227*), switch the required pump from automatic mode (Fig. 154/1) to manual mode (Fig. 154/2).



↳ *Section 5.4.1 “Executing adjustment mode with one pump” on page 100* provides an example for using this function.

5.7.5 Using the application oscilloscope during operation

You can use the application oscilloscope to assign a process size or a parameter value to a channel that displays the development of the process size or the parameter value graphically.

A channel can be filled with parameters and process sizes from the submenus for I/O configuration, the application modules, and the pumps. For information on the corresponding available parameters and process sizes, also see:

- I/O configuration: ↳ *Section 5.6.1 “Setting I/O parameters” on page 168*
- Application modules: ↳ *Section 5.3 “Application modules” on page 91*
- Pumps: ↳ *Section 5.6.1.5 “Setting pump parameters” on page 183*

The pump controller can display the development of the parameter values or process sizes on two screens:

- The display on the main menu level takes up half of the screen width and can display up to 8 channels simultaneously.
- The display on the submenu level takes up the entire screen width and can display up to 16 channels simultaneously.

1. Tap  in the navigation bar.
⇒ “*Application oscilloscope*” (Fig. 155) opens.



Fig. 155 indicates an application oscilloscope that is still to be configured.

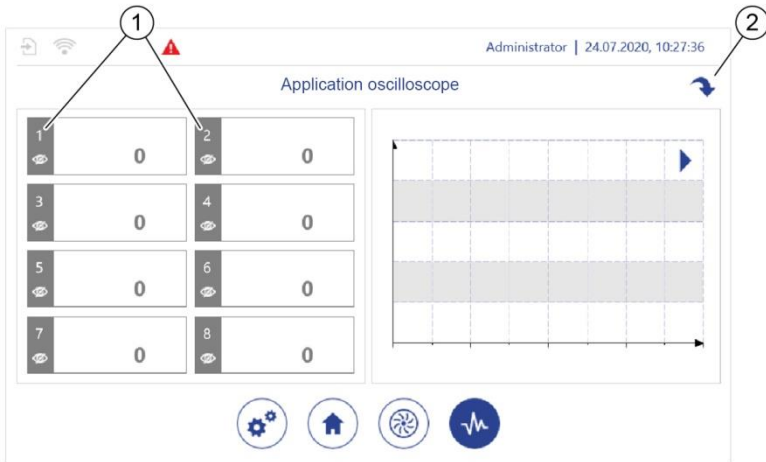

Oscilloscope_overn/levr.png

Fig. 155: “Application oscilloscope” (unconfigured)

2. Configure a channel.

- In order to use the graphical display of parameter values or process sizes on the main menu level, tap one of the 8 channels on the main menu level (Fig. 155/1).
- In order to use the graphical display of parameter values or process sizes on the submenu level, proceed as follows:
 - Tap the header bar  in order to switch to the submenu level (Fig. 155/2).
 - ⇒ The “Full view” submenu opens (Fig. 156).
 - ⇒ The graphical display of the channel values is displayed in full screen width.

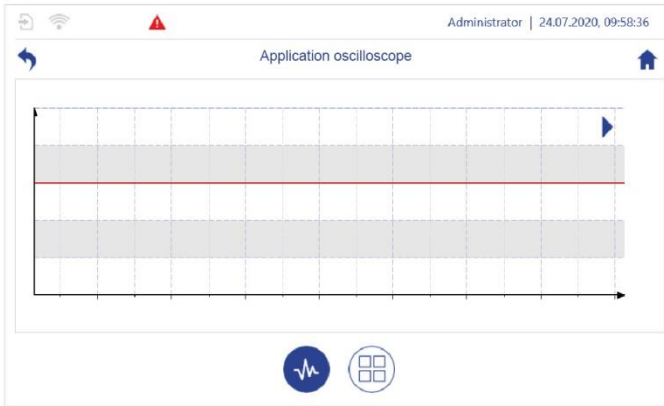

Oscilloscope_Full-view.png

Fig. 156: "Full view" submenu



Application-oscilloscope_navigation

Fig. 157: Jump marks in the "Full view" submenu

- 1 Shows a graphical display of up to 8 channels.
- 2 Enables values from up to 16 channels to be displayed and changed.
 - Tap  in the navigation bar to display the available channels.
 - ⇒ An overview of all available channels opens (Fig. 158).

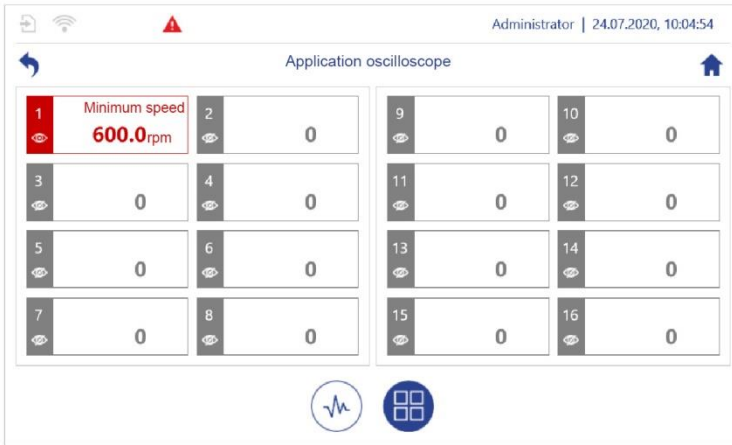

Oscilloscope_discrete_values.png

Fig. 158: Overview of available channels

- Tap a channel.
- ⇒ The “Application oscilloscope – Channel x” parameter selection opens.
3. In the “Application oscilloscope – Channel x” parameter selection, navigate to the parameter or process size from the submenus for the I/O configuration, the application modules, and the pumps, which are to be displayed by the channel (example: Fig.159).

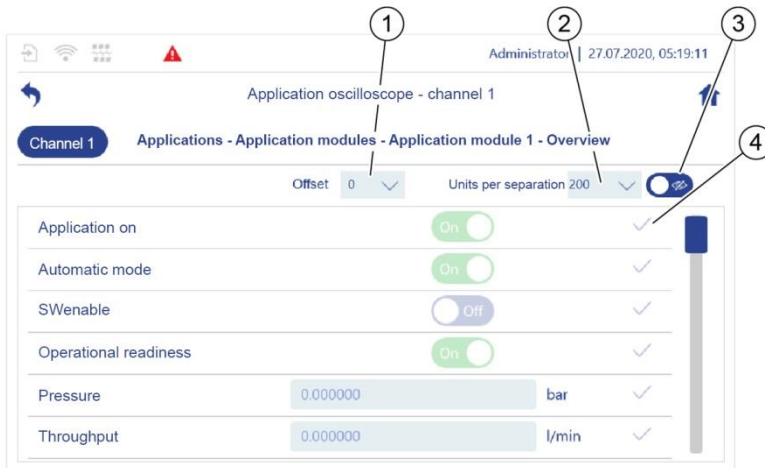

Oscilloscope_application-01.png

Fig. 159: Selecting the process size for the display in the application oscilloscope

- 1 Defines the number of grid lines by which the curve will be moved in the application oscilloscope's coordinate system. In this way, you can move a curve that is covering another curve.
 - 2 Defines the gaps in the application oscilloscope's coordinate system. In this way, you can set the size to which the line diagram for this channel is scaled.
If you set the "Auto" value, the pump controller determines the scaling value automatically.
 - 3 Defines whether the configured channel is hidden in the application oscilloscope.
 - 4 Fills the channel with this parameter or the process size.
4. Set the *Offset* for the required parameters or the required process size (Fig.159/1).
 5. Set the *Units per separation* for the required parameters or the required process size (Fig.159/2).
 6. Define whether the configured channel is hidden or shown in the application oscilloscope (Fig.159/3).
 7. Tap the tick at the end of the row for the required parameter or the required process size in order to fill the channel with this parameter or this process size (Fig.159/4).
⇒ Your selection is saved, and the application oscilloscope is displayed.

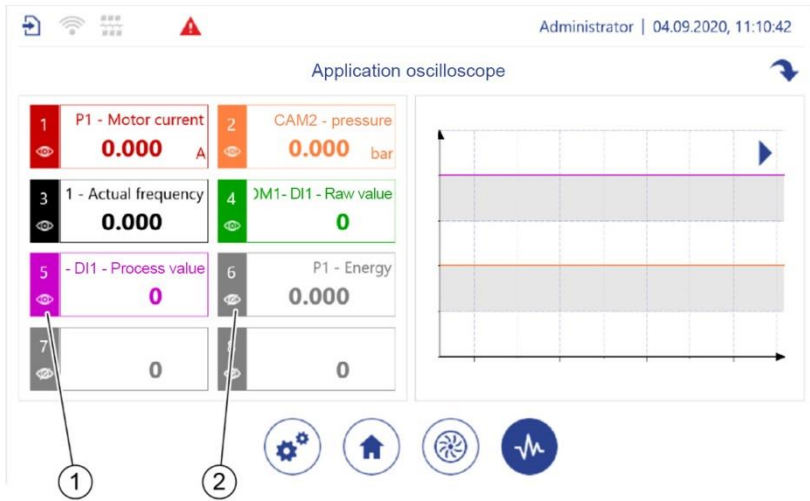

Fig. 160: configured application oscilloscope (example)

- ⇒ Shown, configured channels are marked in the colour of the corresponding curve (Fig. 160/1).
- ⇒ Hidden or unconfigured channels are greyed out (Fig. 160/2).

5.8 Shutting down the pump controller

- ▶ To switch off, disconnect the power supply.



Hardware and software are not damaged by this hard shutdown.

Continuous operation



The pump controller is designed for continuous operation. Only shut down pump controllers for extended operational breaks or maintenance and troubleshooting work.

5.9 Re-commissioning after an extended shut-down

If there is a power interruption, the pump controller can run the clock for up to 30 days thanks to its own energy buffer.



A pump controller that has been de-energised for more than 30 days is considered to have been shut down for an “extended period”.

1. ↪ Observe *section 5.1 “Switching on and logging in” on page 52*.
2. If no NTP server via which the internal clock can obtain the current time is selected (↪ *section 6.3 “Automatic time setting” on page 246*), set the calendar and the clock to the current date and time manually.
 - ↪ *Section 5.6.2.4 “Setting the date and time” on page 196*

6 Additional functions

The pump controller has the following additional functions.



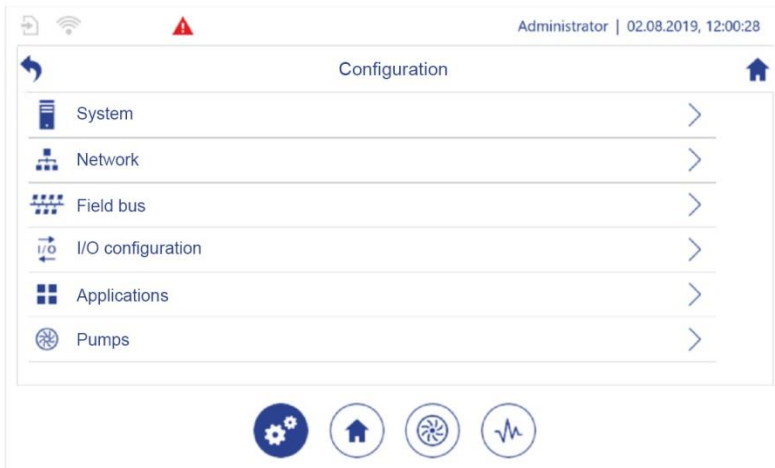

Designation	Description
Long-term logging	This function enables parameter and process value developments to be recorded for an extended period. The recorded values can be exported to a spreadsheet program for evaluation.
WLAN function	This function enables the pump controller to be connected to a network via WLAN.
Automatic time setting	This function enables the pump controller to obtain the current date and the current time via an NTP server.

Opening the basic settings for additional functions



Configuration-menu_01.png

Fig. 161: "Configuration"



1. Tap  in the navigation bar.
 - ⇒ The “*Configuration*” (Fig. 161) view opens.
2. Navigate as follows depending on the required settings:
 -  Section 6.1 “Using logging” on page 240: Fig. 161/1
 -  Section 6.2 “WLAN” on page 244: Fig. 161/2
 -  Section 6.3 “Automatic time setting” on page 246: Fig. 161/2

6.1 Using logging

The long-term logging function can be used to record several process sizes or parameters simultaneously.



The channel can be filled with parameter values and process sizes from the sub-menus for I/O configuration, the application modules, and the pumps.

For information on the corresponding available parameter values and process sizes, also see:

- I/O configuration:  Section 5.6.1 “Setting I/O parameters” on page 168
- Application modules:  Section 5.3 “Application modules” on page 91
- Pumps:  Section 5.6.1.5 “Setting pump parameters” on page 183



Also note the following when working with files:

-  Section 5.2.10 “File manager” on page 81
-  “File operations” on page 200
-  Section 7.2.1 “Backup and restore preparation” on page 250

1. In “*Configuration*”, tap “*System*”.
 - ⇒ “*Configuration – System*” opens.
2. In “*Configuration – System*”, tap “*Logging*”.
 - ⇒ “*Configuration – System – Logging*” opens.

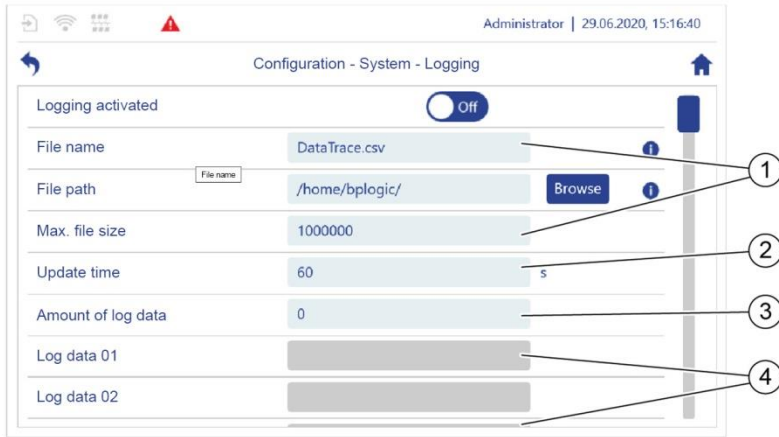

Configuration_System_Logging-01.png

Fig. 162: "Configuration – System – Logging"

3. Change the file properties if required (Fig. 162/1). Note that the file size is specified in bytes.
4. Specify the interval at which the log data is to be updated (Fig. 162/2).
5. Define the number of parameters or process sizes for which the log data is to be recorded (Fig. 162/3).
6. Tap the required channel, "Log data x" via which the required parameter value or the required process size is to be displayed (Fig. 162/4).
 - ⇒ The "Logging – Channel x" parameter selection (Fig. 163) opens.

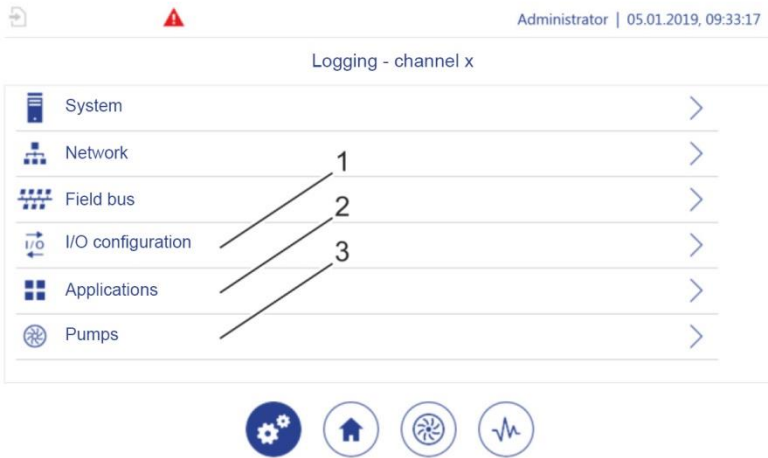
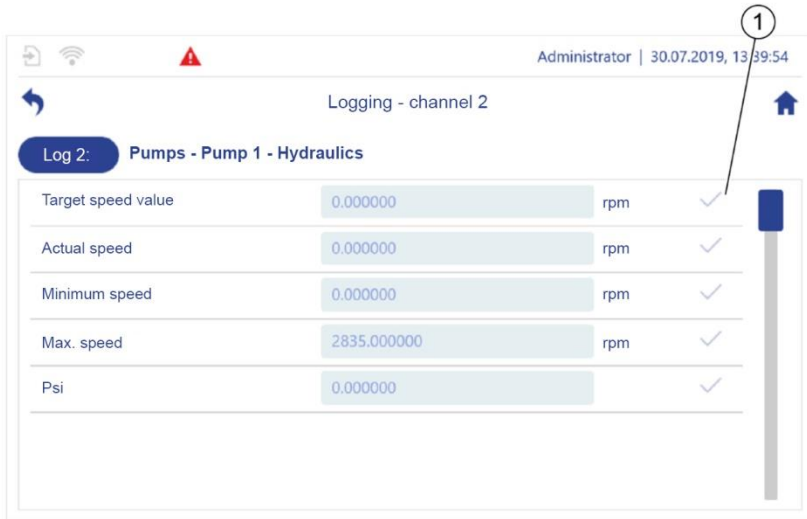

Fig. 163: "Logging – Channel x"

- 7. Use the "Logging – Channel x" parameter selection to navigate to the parameter value or the process size from the submenus for the I/O configuration (Fig. 163/1), the application modules (Fig. 163/2) and the pumps (Fig. 163/3), which are to be displayed via the channel (example Fig.164).
- 8. Tap the tick at the end of the row for the required parameter or the required process size in order to fill the channel with this parameter or this process size (Fig.164/1).



Logging_selector-01.png

Fig.164: Selecting the process size for long-term logging (example)

- ⇒ Your selection is saved and displayed in the “*Configuration – System – Logging*” menu (Fig.165/1).

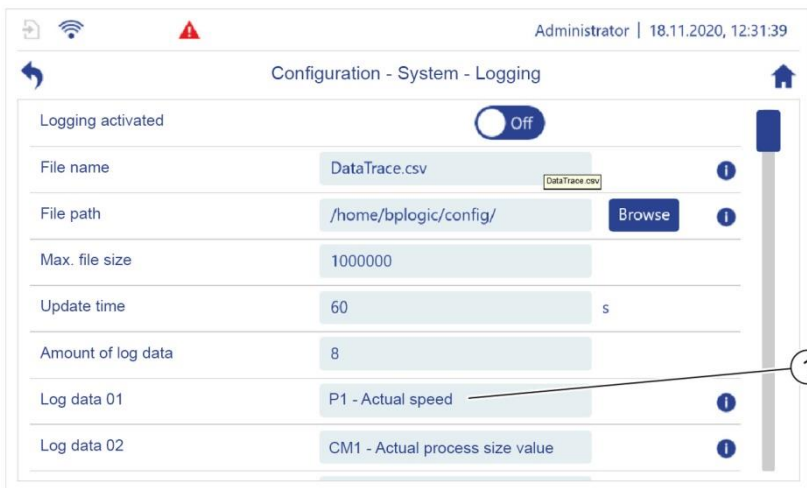

Logging_example-01.png

Fig.165: Logging the actual speed for pump 1 (example)

9. In “Amount of log data”, set the number of channels that are to be recorded, e.g. in the event that only part of the configured channels is to be recorded.
⇒ The long-term logging function can be activated.

Exporting data



Logging data is first written to the system.

- To export the logging data ↪ “File operations” on page 200.

6.2 WLAN

You can connect the pump controller to a network via WLAN.

Switching WLAN on/off

Prerequisites:

- A WLAN stick that is ready for operation is in the service access.
- The parameters have been set ↪ section 5.6.4 “Setting WLAN module parameters” on page 205.

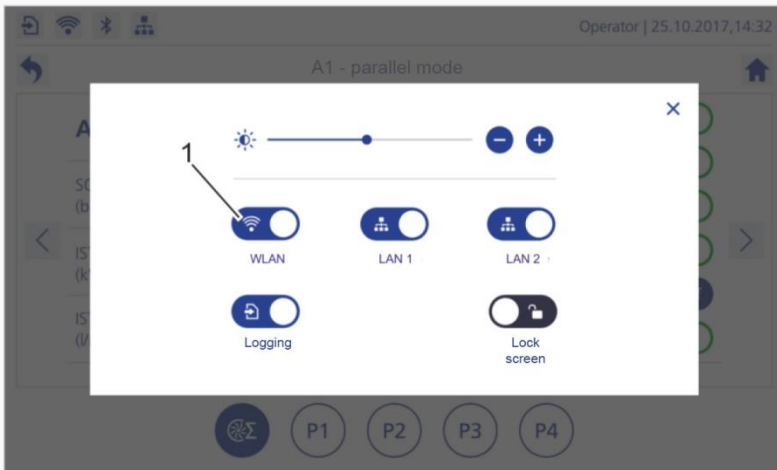

Fig. 166: “Quick access” dialogue

- Open the “Quick access” dialogue ↪ “Vertical swiping” on page 71.
- Switch the WLAN on (Fig. 166/1).

Or:

Administrator | 05.01.2019, 10:21:09

Configuration - Network - WLAN server

Projected	<input type="checkbox"/> Off	WLAN SSID	BP Logic
Active	<input type="checkbox"/> Off	WLAN channel	6
IP address	192.168.3.100	Password	11111111
Subnet mask	255.255.255.0		

Save

Fig. 167: “WLAN Server”

1. In “Configuration”, tap “Network”.
⇒ “Configuration – Network” opens.
2. In “Configuration – Network”, tap “WLAN”.
⇒ “Configuration – Network – WLAN Server” (Fig. 167) opens.
3. Ensure that “Projected” was set to “On”.
4. Tap “On” actively to switch on the WLAN function.

6.3 Automatic time setting

Automatic time setting enables the pump controller to obtain the current date and the current time via an NTP server.

Prerequisite:

The pump controller must be connected to a network in which an IP connection to an external time server is possible.

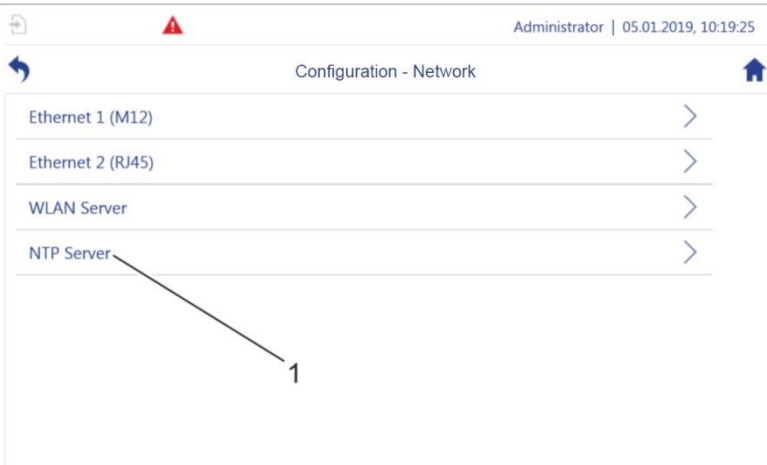

Fig. 168: “Configuration – Network”

1. Tap “Network”.
⇒ “Configuration – Network” (Fig. 168) opens.
2. Tap “NTP server” (Fig. 168/1).
⇒ “Configuration – Network – NTP Server” (Fig. 169) opens.

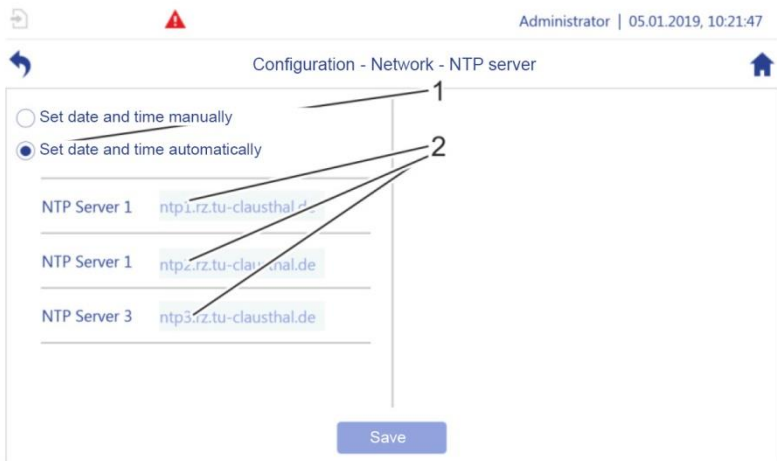



Fig. 169: “Configuration – Network – NTP Server”

3. Select one of the pre-configured NTP servers (Fig. 169/2) or enter the required server address.
4. Tap “Save” to save the selected settings.
5. Use  to exit the screen.



To set the time and date manually  [section 5.6.2.4 “Setting the date and time” on page 196.](#)

7 Performing maintenance

Hardware



The pump controller's hardware is maintenance-free apart from cleaning.

7.1 Cleaning the housing

- Materials:
- Standard glasses cleaning cloth
 - Soft cloth



CAUTION!

Do not use an aggressive solvents or cleaning agents!

Cleaning the housing

1. Wipe the housing with a damp, soft cloth from time to time or if dirty.

Cleaning the touchscreen

2. Clean the touchscreen with a damp, soft cloth from time to time or if dirty.



NOTICE!

Scratching the touchscreen!

- Do not use any sharp objects for cleaning.

7.2 Backup and restore

You can use the “*Backup & Restore*” menu to backup the pump controller’s software or only parts of the software and, if required, to restore it or transfer it to a different pump controller.

You can choose from the following options:

- Application: Backup the pump controller’s application software (backs up functions such as pressure increase, saw tooth cycle mode, logging function, oscilloscope).
- Settings: Save all parameters that can be saved on the pump controller.
- System: Backup the entire pump controller system software including the application software and the restorable setting parameters.

Note that you cannot save the pump controller’s setting parameters, but only the restorable settings parameters.

- The pump controller’s restorable setting parameters have a white background (Fig. 170/1).
- All pump controller setting parameters that you cannot save have a grey background (Fig. 170/2).



Fig. 170: Setting parameters that can and cannot be saved on the pump controller

The setting parameters that are restorable depend on the pump controller configuration file that is used. Only the manufacturer can edit the configuration file.

7.2.1 Backup and restore preparation

Materials:

- USB storage medium

1. Exposing the service access: ↪ *Section 5.6.4 ‘Setting WLAN module parameters’ on page 205* handling step 1 and handling step 2.

Inserting storage media

2. If the entire system software is to be backed up, ensure that the USB storage medium's designation is “BOOT”.

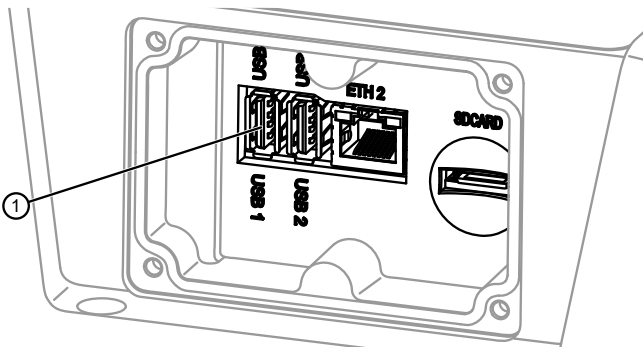



Fig. USB_connections.svg

Fig. 171: USB connections, microSD slot

3. Insert the USB storage medium into USB connection 1 (Fig. 171/1).

Backup and restore

4. Tap  in the navigation bar.
 - ⇒ The “Configuration” view opens.
5. In “Configuration”, tap “System”.
 - ⇒ “Configuration – System” opens.
6. In “Configuration – System”, tap “Backup & Restore”.
 - ⇒ “Configuration – System – Backup & restore” (Fig. 172) opens.

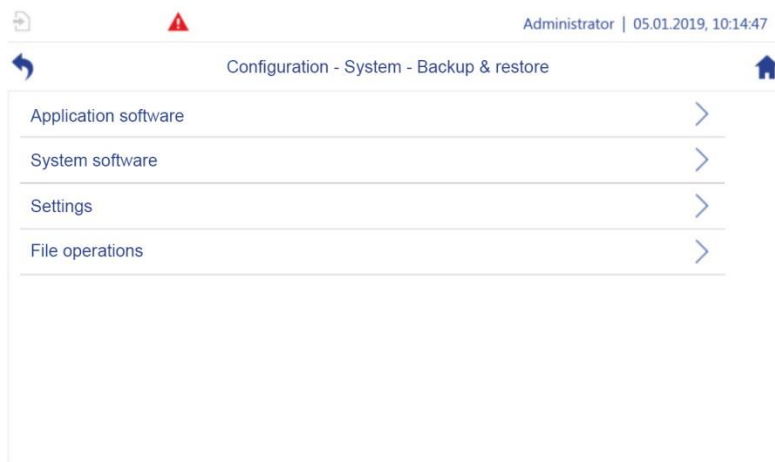

Fig. 172: “Configuration – System – Backup & Restore”

- ↪ *Section 7.2.2* “Backing up and updating application modules” on page 251
- ↪ *Section 7.2.3* “Backing up and updating the system software” on page 254
- ↪ *Section 7.2.4* “Backing up and updating settings” on page 257
- ↪ “File operations” on page 200

7.2.2 Backing up and updating application modules

The following steps describe how you can back up and update the pump controller’s application software. The pump controller’s application software comprises all application functions such as pressure increase, saw tooth cycle mode, logging function, oscilloscope, etc.

Prerequisite:

Preparation in accordance with ↪ *section 7.2.1* “Backup and restore preparation” on page 250 has been completed.

1. In “*Configuration – System – Backup & Restore*”, tap “*Application software*”.
 - ⇒ “*Configuration – System – Backup & restore – Application software*” (Fig. 173) opens.

Backing up

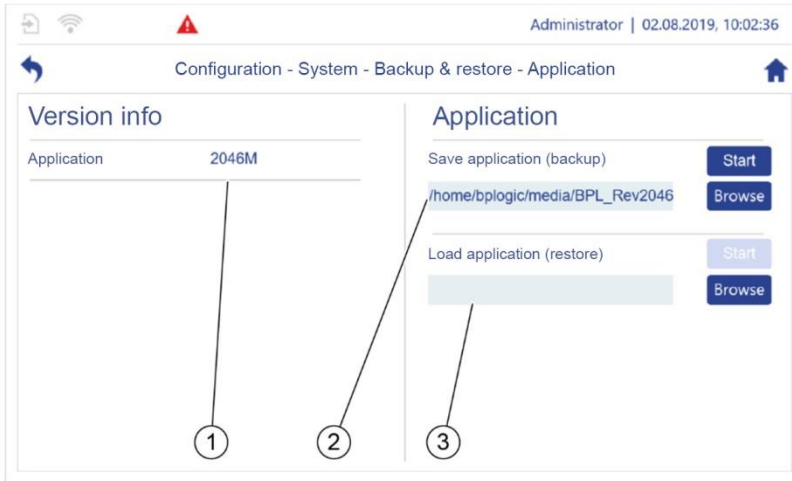

Configuration_System_Applications.png

Fig. 173: “Configuration – System – Backup & Restore – Application software”



For information regarding setting up external storage, see [section 5.6.7 “Exchanging data” on page 219](#).

2. Use “Browse” (Fig. 173/2) to select the required file path.
3. Tap “Start” to start the backup.
 - ⇒ The backup runs (Fig. 174).

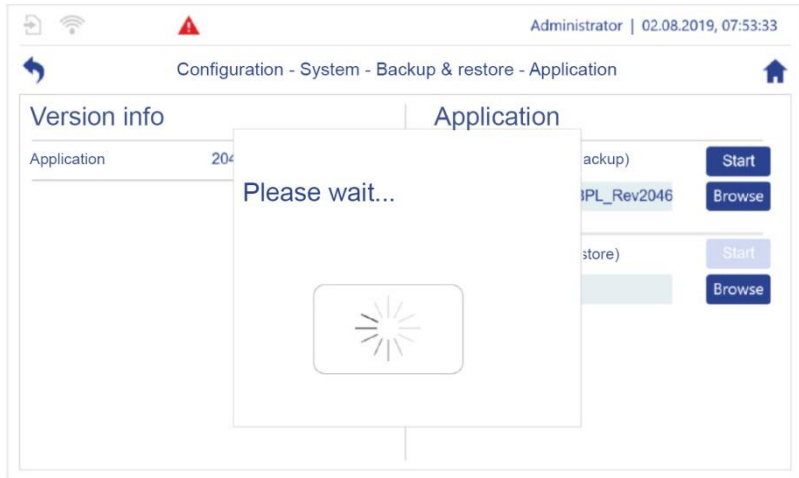

Waiting_message.png

Fig. 174: Backup running

⇒ A message confirms that the backup was successful (Fig. 175).

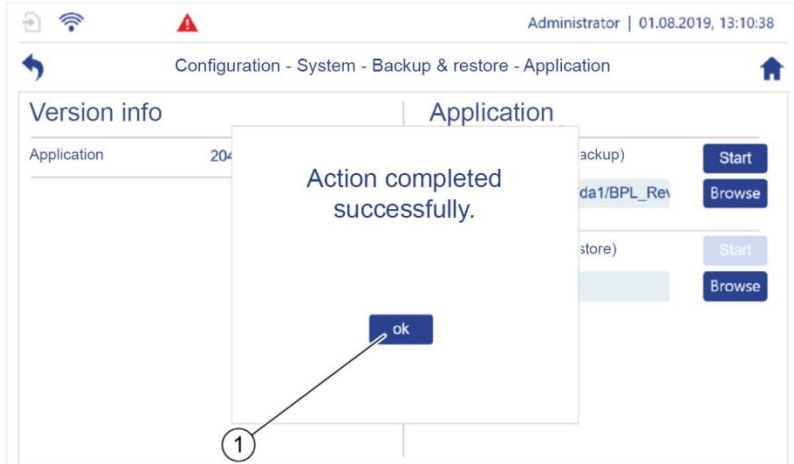

Completed_message-01.png

Fig. 175: Backup completed successfully

4. Tap "OK" (Fig. 175/1) to confirm the message and to close.
5. Eject the storage device and remove it.

6. Keep the backup safe.

Restoring

7. Use the version info (Fig. 173/1) to check whether a current version is installed.
8. Use “Browse” (Fig. 173/3) to select the file path for the current version.
9. Press “Start” to start restoring.
10. After restoring is complete, eject the source storage device and remove it.
11. Closing the service access: ↪ *Section 5.6.4 ‘Setting WLAN module parameters’ on page 205*, handling step 4 and handling step 5.



For information regarding ejecting a removable storage device, see ↪ *section 5.7.2 ‘Ejecting the removable storage device safely’ on page 225*.

7.2.3 Backing up and updating the system software

The following steps describe how you can back up and update the entire system software, including the application software, the setting parameters and the operating system.

Backing up and updating the application software can take up to 30 minutes.

Prerequisites:

- Preparation in accordance with ↪ *section 7.2.1 ‘Backup and restore preparation’ on page 250* has been completed.
 - The USB storage medium that is used has the “BOOT” designation.
1. In “*Configuration – System – Backup & Restore*”, tap “*System software*”.
⇒ “*Configuration – System – Backup & restore – System software*” (Fig. 176) opens.

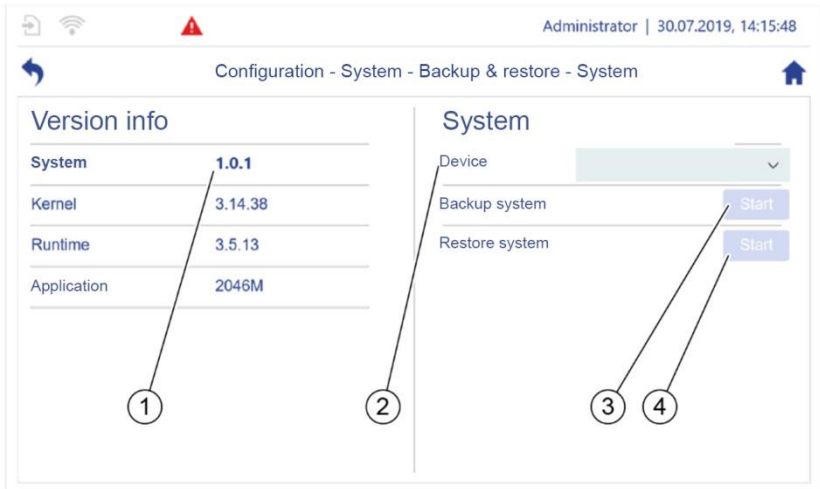

Backup_system_software.png

Fig. 176: "Configuration – System – Backup & Restore – System software"

2. Use "Device" to select a storage device for the backup or for restoring (Fig. 176/2).

Backing up

3. In "Backup system" (Fig. 176/3), tap "Start" to start the backup.
 - ⇒ A message requests that you restart the device (Fig. 177).

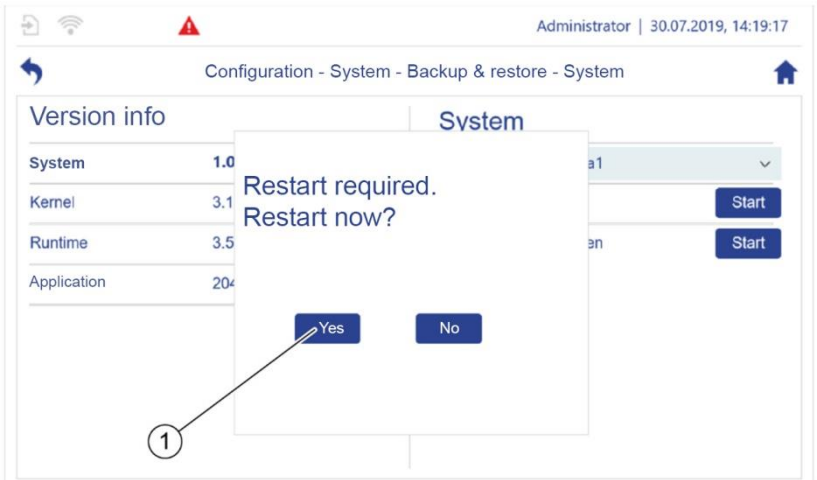

Restart_message-01.png

Fig. 177: "Restart required" message

4. Tap "Yes" (Fig. 177/1).

- ⇒ The backup runs and a loading screen with a progress bar is displayed (Fig. 178).

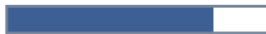

Backup_progress.png

Fig. 178: Backup progress

- ⇒ After backing up, the pump controller switches off automatically. It remains switched off until the power supply is disconnected and restored.

5. After backing up is complete, eject the storage device and remove it.
6. Keep the system backup safe.

Restoring

Materials:

- USB storage medium with current system backup

7. Use the version info (Fig. 176/1) to check whether a current version is installed.
8. In “*Restore system*” (Fig. 176/4), tap “*Start*” to restore the software.
9. After restoring is complete, eject the source storage device and remove it.
10. Closing the service access: ↪ *Section 5.6.4 ‘Setting WLAN module parameters’ on page 205*, handling step 4 and handling step 5.
11. Restarting the system:
 - ↪ *Section 5.6.2.7 ‘Device restart’ on page 201*.

7.2.4 Backing up and updating settings

The following steps describe how you can back up and update all setting parameters.

Backing up setting parameters can take up to 5 minutes.

Prerequisite:

↪ *Section 7.2.1 ‘Backup and restore preparation’ on page 250* has been completed.

1. In “*Configuration – System – Backup & Restore*”, tap “*Settings*”.
 - ⇒ “*Configuration – System – Backup & restore – Settings*” (Fig. 179) opens.

Backing up

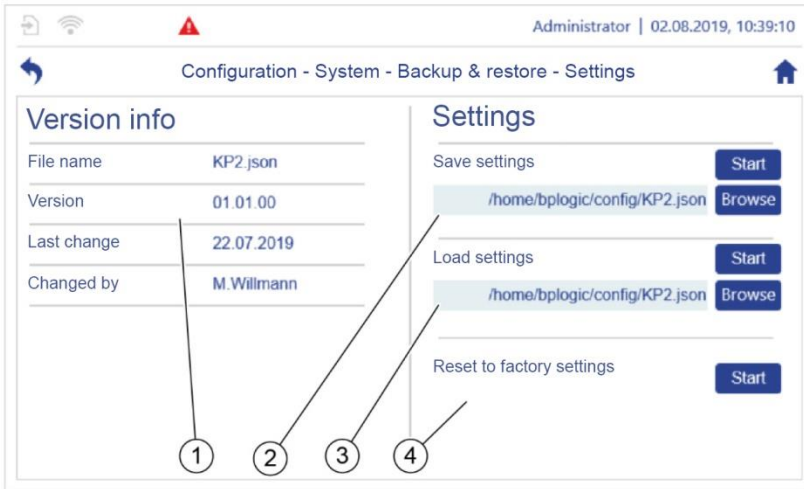

Configuration_System_Settings.PNG

Fig. 179: “Configuration – System – Backup & Restore – Settings”

2. Use “Browse” to select the required file path (Fig. 179/2).
3. Tap “Start” to start the backup.
⇒ The backup runs (Fig. 180).

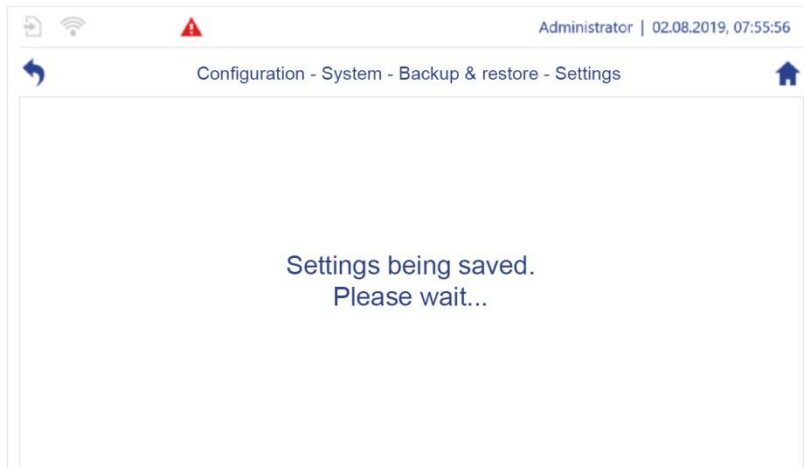

Settings_backup.png

Fig. 180: Backing up the setting parameters runs

4. After backing up is complete, eject the storage device and remove it.
5. Keep the backup safe.

Restoring

6. Use the version info (Fig. 179/1) to check whether a current version is installed.
7. Use “Browse” (Fig. 179/3) to select the file path for the current version.
8. Press “Start” to start restoring.
9. After restoring is complete, eject the source storage device and remove it.
10. Closing the service access: ↪ *Section 5.6.4 ‘Setting WLAN module parameters’ on page 205*, handling step 4 and handling step 5.

Resetting



11. Tap “Reset to factory settings” (Fig. 179/4) in order to discard all changes and to restore the condition as delivered.
12. Restarting the system:
↪ *Section 5.6.2.7 ‘Device restart’ on page 201*



For information regarding ejecting a removable storage device, see ↪ *section 5.7.2 ‘Ejecting the removable storage device safely’ on page 225*.

7.3 Event messages

The pump controller uses three types of event message to inform you of the system state:

Icon	Type of event message	Description
	Error message	Reports software and hardware faults. An error message that has triggered can cause application modules to be switched off automatically and operational readiness signals to be reset.
	Warning message	Reports software and hardware faults. Warning messages being triggered do not cause any application modules to be switched off or operational readiness signals to be reset.
	Information	Reports system status changes, e.g. a changed speed for the I/O cycles. Information being triggered does not cause any application modules to be switched off or operational readiness signals to be reset.

7.3.1 Layout of an event message

Event messages are displayed in the “*Detailed event message*” dialogue box (Fig. 181). All event messages are laid out according to the following principle:

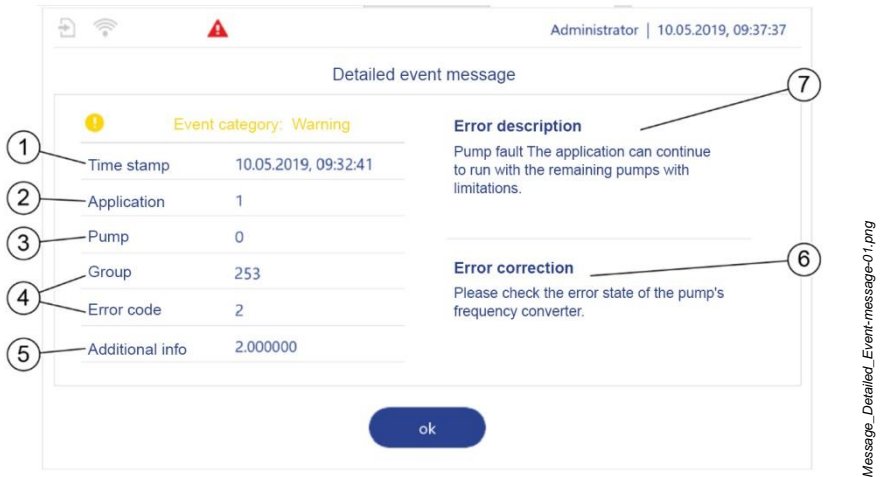

Fig. 181: Layout of a warning message (example)

- | | |
|-----------------------------------------------------------------------------------------------------------------------------------------------------------------------------------------------------------------------------------------------------------------------------------------------------------------------------------------------------------------------------------------------------------------------------------------|-------------------------------------------------------------------------------------------------------------------------------------------------------------------------------------------------------------------------------------------|
| <p>1 Indicates the date and time at which the event message was triggered.</p> <p>2 Indicates the number of the application module that triggered the event message. If “0” is displayed, no application module is assigned to the event message.</p> <p>3 Indicates the number of the pump that triggered the event message. If “0” is displayed, no pump is assigned to the event message.</p> <p>4 Identifies the event message.</p> | <p>5 Used for error identification. You require this number if you contact the manufacturer’s customer service for troubleshooting.</p> <p>6 Designates error rectification steps.</p> <p>7 Describes the cause of the event message.</p> |
|-----------------------------------------------------------------------------------------------------------------------------------------------------------------------------------------------------------------------------------------------------------------------------------------------------------------------------------------------------------------------------------------------------------------------------------------|-------------------------------------------------------------------------------------------------------------------------------------------------------------------------------------------------------------------------------------------|

7.3.2 Acknowledging and closing event messages

As soon as an event message is triggered, the “*Detailed event message*” dialogue box opens. You can use a button to close the dialogue box. The number and ap-

pearance of the buttons depends on whether the event message that is displayed must be acknowledged.

You can use the “*Event list*” menu to call and view closed event messages even if the cause of the event message has already been rectified (↪ 7.3.3 “*Event list* menu” on page 263).

Closing the event message

An event message that does not have to be acknowledged only receives the “OK” button.

You can close the event message in two ways:

- ▶ Close the event message by:
 - Tapping the “OK” button.
 - ⇒ The event message is closed and marked as “active” in the “*Event list*” menu.
 - Rectify the cause of the event message
 - ⇒ The event message is closed and marked as “inactive” in the “*Event list*” menu.

Acknowledging the event message

An event message that must be acknowledged receives the two buttons “*Ignore*” and “*Acknowledge*”.

You can close the event message in two ways:

- ▶ Close the event message by:
 - Tapping the “*Ignore*” button.
 - ⇒ The event message is closed and marked as “active” in the “*Event list*” menu.
 - Tapping the “*Acknowledge*” button.
 - ⇒ The event message is closed.
 - ⇒ Depending on whether the cause of the event message has been rectified, the event message is either marked as “active” or “inactive” in the “*Event list*” menu.

7.3.3 “Event list” menu

All event messages are saved in the “*Event list*” menu even if the cause of the event message has already been rectified. This way, you can track which faults have occurred on the pump controller, even after rectifying the error.

The screenshot shows the 'Event list' menu interface. At the top, it displays 'Administrator | 13.11.2019, 10:40:28'. Below the title 'Event list', there is a filter option 'Only active events' (unchecked) and a 'Delete list' button. The main content is a table with the following columns: Time stamp, App, Pump, Description, and Seq.No. The table contains several rows of event messages. Annotations with numbered circles (1-5) point to specific elements: 1 points to a yellow circle icon, 2 points to bold text in the description, 3 points to a yellow circle icon, 4 points to a greyed-out triangle icon, and 5 points to a vertical scrollbar on the right side of the table.

Time stamp	App	Pump	Description	Seq.No.
13.11.2019, 10:33:42	1	0	Pump fault The applic...	5
13.11.2019, 10:33:43	1	2	Communication: Message	6
13.11.2019, 10:33:43	1	3	Communication: Message	7
13.11.2019, 10:33:43	1	0	The application was st...	8
13.11.2019, 10:34:35	2	0	HW enable for FC6 not s...	9
13.11.2019, 10:34:41	2	0	HW enable for FC7 not s...	10
13.11.2019, 10:34:41	2	0	HW Enable fail FHP right...	11

Event-list_Overview-01.png

Fig. 182: “Event list”

- | | | | |
|---|----------------------------------------------------------|---|-------------------------|
| 1 | Read event message. | 3 | Active event message. |
| 2 | Unread event message. | 4 | Inactive event message. |
| 5 | List of all saved event messages in chronological order. | | |

All event messages are marked as “unread” in bold (Fig. 182/2) until they are opened using the “*Event list*” menu (↪ section 7.3.3.2 “Displaying event messages” on page 266).

Active event messages are marked with coloured icons in the “*Event list*” menu (Fig. 182/3). The icons for inactive event messages are greyed out (Fig. 182/4).

The conditions under which an event message is marked as “active” depend on whether it must be acknowledged:

- An event message that does not have to be acknowledged is displayed as active until the cause is rectified.

- You can use the “Ignore” button to close an event message that has to be acknowledged without acknowledging the event message. The event message is displayed as active until it is acknowledged even if the cause has already been rectified.

Open the “Event list” menu

- ▶ Tap the “Event list” button in the status bar (Fig. 183/1).

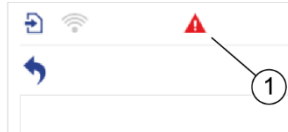

Fig. 183: “Event list” button

Event_list_Header-01.png

7.3.3.1 Hiding and deleting event messages

You can use both buttons in the “Event list” menu’s header to hide the inactive event messages or to delete all saved event messages.



Fig. 184: Changing the display

Event_list_excerpt-01.png

Hiding inactive event messages

1. Tap the “Only active events” button (Fig. 184/1).
 - ⇒ The “Event list” menu only displays active event messages.
2. In order to show the inactive event messages again, tap the “Only active events” button again.

Deleting all saved event messages



You cannot delete the saved event messages individually. You can only delete all event messages that are saved in the “*Event list*” menu simultaneously.

Deleted event messages cannot be restored.

If you delete an event message for which the cause has not yet been rectified, a new event message is generated immediately.

- ▶ Tap the  button (Fig. 184/2).
 - ⇒ All saved event messages are deleted.

7.3.3.2 Displaying event messages

The “*Event list*” menu supports you when rectifying errors by enabling you to display individual event messages.

1. Open the “*Event list*” menu.
2. Tap the required event message in the “*Event list*” menu.
 - ⇒ The event message opens in the “*Detailed event message*” dialogue box.
3. Rectify the error in accordance with the instructions in the event message.



If the error cannot be rectified using the pump controller, refer to  “Further applicable documents” on page 7.

4. If the event message must be acknowledged, tap the “Acknowledge” button.

7.4 Fault table

Error description	Cause	Remedy
System does not start.	No operating system on the flash drive, no external drive with operating system	Insert a USB storage medium or a microSD card containing the current operating system. ↳ <i>Section 5.6.7 “Exchanging data” on page 219</i>
	Power supply faulty	Check the power supply.
No WLAN function	WLAN off	↳ <i>Section 6.2 “WLAN” on page 244</i>
	No WLAN dongle inserted	
	WLAN is not projected	↳ <i>Section 5.6.4 “Setting WLAN module parameters” on page 205</i>
	Metallic cover plate inhibits radio waves	Use a plastic cover plate.
Incorrect date and time entries	Pump controller was de-energised for an extended period.	↳ <i>Section 5.9 “Re-commissioning after an extended shutdown” on page 238</i>
	NTP server cannot be reached.	↳ <i>Section 6.3 “Automatic time setting” on page 246</i>
No write authorisation	Another user is already logged in.	Log the other user out.

Error description	Cause	Remedy
No release to the higher-level controller	Pump or application in manual mode	Set pumps and applications to automatic mode.
	An error is present.	↳ <i>Section 7.3 “Event messages” on page 260</i>
The pump controller no longer reacts.	System crash	↳ <i>Section 7.5 “Restarting in the event of errors” on page 268</i>

7.5 Restarting in the event of errors

1. Use the touchscreen to perform a restart ↳ *Section 5.6.2.7 “Device restart” on page 201.*

If the pump controller no longer shuts down

2. To switch off, disconnect the power supply.



Hardware and software are not damaged by this hard shutdown.

3. Wait a while and then proceed in accordance with ↳ *section 7.2 “Backup and restore” on page 249.*
4. If there are ongoing malfunctions:
 - ↳ *Section 7.3 “Event messages” on page 260*
 - ↳ *Section 7.2.3 “Backing up and updating the system software” on page 254*
 - ↳ *Section 7.2.4 “Backing up and updating settings” on page 257*

8 Technical data

8.1 Device properties

Specification	Value	Unit
Dimensions (H x W x D)	180 x 270 x 80	mm
Weight	approx. 2	kg
Pump controller housing protection category	IP65 ¹⁾	
Pump controller housing protection class	III	
Pump controller housing degree of soiling	2	
Screen diagonal	7	"
Resolution	800 x 480	px

¹⁾ not checked by UL

- Housing material: Die-cast aluminium
- Colour display
- Can be used vertically and horizontally
- Capacitive touchscreen

8.1.1 Functions

- Maximum of 6 application modules (more upon request)
- Application modules:
 - (Frequency) adjustment mode
 - Control mode
 - Parallel mode
 - Pressure increase
 - Saw tooth cycle mode
 - Offset control
 - Wear detection
 - Logic module

8.1.2 Frequency converter

- Maximum of 6 frequency converters (more upon request)
- Frequency converters supported by Modbus RTU:
 - ABB
 - Brinkmann
 - Danfoss
 - Emotron
 - Fuji
 - Kostal
 - Mitsubishi

8.1.3 Interfaces

- Ethernet (for service and configuration):
 - 10/100 Mbit/s
 - RJ45 connection
- Field bus:
 - Modbus RTU
 - CAN and CANopen (upon request)
 - M12 connection (A-coded)
- Real-time ethernet:
 - PROFINET RT
 - ETHERNET/IP
 - others (upon request)

- M12 connection (D-coded)
- USB:
 - 2 x USB 2.0 host type A socket
 - of which 1 x OTG (USB 2)
- External storage expansion:
 - µSDHC card up to 32 GB

8.1.4 WLAN communication

Specifications for the WLAN dongle:

- EDIMAX EW-7811Un
or
- all comparable products with the Realtek RTL8188CUS chip set

Specification	Value	Unit
Maximum possible insertion depth	15	mm
Typical range ¹⁾	20	m

¹⁾ When using the plastic cover for the service access

8.2 Ambient and operating conditions

Specification	Value	Unit
Permissible operating temperature	-20 – 55	°C
Permissible storage temperature	-30 – 80	°C
Maximum relative humidity (without condensation)	95	%
Maximum operating height	2000	m
Strain due to hazardous materials	DIN EN 60068-2-60	
Max. hazardous material concentration at a relative humidity of less than 75 %	SO ₂ : < 0.20 NO ₂ : < 0.20 H ₂ S: < 0.01 CL ₂ : < 0.01	ppm

- Operating indoors in the industrial/commercial sector.
- Designed for continuous operation.

8.3 Electrical properties

8.3.1 Pump controller

Specification	Value	Unit
Power supply (U_{LS} , U_A) ¹⁾	24	VDC
Tolerable voltage fluctuations	-25 – 30	%
Power consumption ²⁾	400	mA
Maximum actuator current I_A ³⁾	14	A
Maximum logic and sensor current I_{LS} ³⁾	4	A
Power supply connection	M12 Power (L-coded)	
Real-time clock power reserve ⁴⁾	30	days

1) The 24 V power supply must meet the requirements of protective extra-low voltage (PELV) or safety extra-low voltage (SELV protection class III).

2) Typical current consumption, with 2 I/O modules, without sensors/actuators

3) Maximum total current that must be limited by installing external fuses.

4) at a drift of $< \pm 2$ s per day

8.3.2 I/O module 1

I/O module 1 connections

Specification	Value	Unit
Maximum total current ¹⁾	1	A
Number of digital inputs	5 + 4 ²⁾	
Number of digital outputs ³⁾	4	
Number of analog inputs	1	
Number of analog outputs	1	

¹⁾ Total current for all supply and signal currents for digital inputs and outputs, and analog inputs and outputs.

²⁾ 5 Digital inputs and 4 digital outputs that can be configured as inputs

³⁾ switchable

- Connection: M12 socket (A-coded)
- Housing material: Die-cast aluminium

Digital input and output for I/O module 1

Specification	Value	Unit
Digital input signal shape ¹⁾	0/24	VDC
Digital input filter time	1	ms
Digital output signal shape ²⁾	0/24	VDC
Max. current per digital output ³⁾	0.4	A

¹⁾ PNP-reading in accordance with EN 61131-2, type 3

²⁾ PNP-switching

³⁾ from the sensor supply per output, short-circuit proof

Analog input and output for I/O module 1

Specification	Value	Unit
Analog input signal shape for current (I) ¹⁾	4 – 20	mA
Analog input signal shape for voltage (V) ¹⁾	0 – 10	V
Analog input resolution	12	Bit
Analog input accuracy ²⁾	± 0.2	%
Analog output signal shape for current (I) ¹⁾	4 – 20	mA
Analog output signal shape for voltage (U) ¹⁾	0 – 10	V
Analog output resolution	12	Bit
Analog output accuracy ²⁾	± 0.2	%
Maximum analog output burden	600	Ω

¹⁾ Signal shape can be switched between mA and V

²⁾ based on the measurement range end value

8.3.3 I/O module 2

I/O module 2 connections

Specification	Value	Unit
Maximum total current for the supply to the digital outputs	1	A
Maximum total current for the supply to the digital inputs, analog inputs and analog outputs	1	A
Number of digital inputs	2	
Number of digital outputs	4	
Number of analog inputs	2	
Number of analog outputs	1	

- Connection: M12 socket (A-coded)
- Housing material: Die-cast aluminium

Digital input and output for I/O module 2

Specification	Value	Unit
Digital input signal shape ¹⁾	24	VDC
Digital input filter time	1	ms
Digital output signal shape ²⁾	24	VDC
Maximum output current ³⁾	2	A
Electrical isolation	500	V

¹⁾ PNP-reading in accordance with EN 61131-2, type 3 in 3 conductor connection method

²⁾ PNP-switching, short-circuit proof in 3 conductor connection method

³⁾ UL 61010-2-201 load types: General Use and Pilot Duty.

Analog input and output for I/O module 2

Specification	Value	Unit
Analog input signal shape in mA ¹⁾	4 – 20	mA
Analog input signal shape in V ¹⁾	0 – 10	V
Analog input resolution	12	Bit
Analog input accuracy ²⁾	± 0.2	%
Analog output signal shape in mA ¹⁾	4 – 20	mA
Analog output signal shape in V ¹⁾	0 – 10	V
Analog output resolution	12	Bit
Analog output accuracy ²⁾	± 0.2	%
Maximum analog output burden	600	Ω

¹⁾ Signal shape can be switched between mA and V

²⁾ based on the measurement range end value

8.4 Connection line requirements

Line	Minimum temperature in C	Minimum cross section in mm ²	Minimum current resistance per connection contact in A
Power supply	+80	1.5	14
M12, 12-pin (X2 connection to I/O module 1)	+80	0.14	0.4
M12, 4/5-pin (X1 – X6 connections to I/O module 2)	+80	0.34	2

8.5 Permits

Permits	Standard	Certificate
USA	UL 61010-1 UL 61010-2-201	E514703 ¹⁾
Canada	CAN/CSA No. 61010-1-12 CAN/CSA C22.2 No. 61010-2-201:18	

¹⁾ when using UL-certified cables in cable categories „CYJL“ or „PVVA“

8.6 Type plate

The type plate is located on the pump controller's housing. It contains the following specifications:

- Manufacturer
- Type
- Year of construction
- Connection values

8.7 Supplied as standard

The following are supplied as standard:

- M12 connection sealing caps
- Mains unit (optional)
- Memory card (optional)
- USB WLAN stick (optional)

9 Storage, transport, dismantling and disposal

9.1 Storage and transport

Storage

Observe the following points when storing the pump controller:

- Store in the original packaging or comparable packaging.
- Protect against moisture.
- Secure to prevent falling and impacts.

Specification	Value	Unit
Permissible storage temperature	-30 – +80	°C

Transport

Observe the following points when transporting:

- Transport in the original packaging or comparable packaging.
The packaging must provide protection against falling and impacts.
- Protect against moisture.
- Secure to prevent falling and impacts.
- Adhere to the permissible storage temperature ↪ “Storage” on page 280.

9.2 Dismantling and disposal

Dismantling

- Staff:
- Manufacturer’s assembly staff
 - Electrician
- Protective equipment:
- Safety shoes

1. Shut the pump controller down and switch it off ↪ *section 5.8 ‘Shutting down the pump controller’ on page 238.*
2. Remove the mains plug to disconnect the pump controller from the power supply.

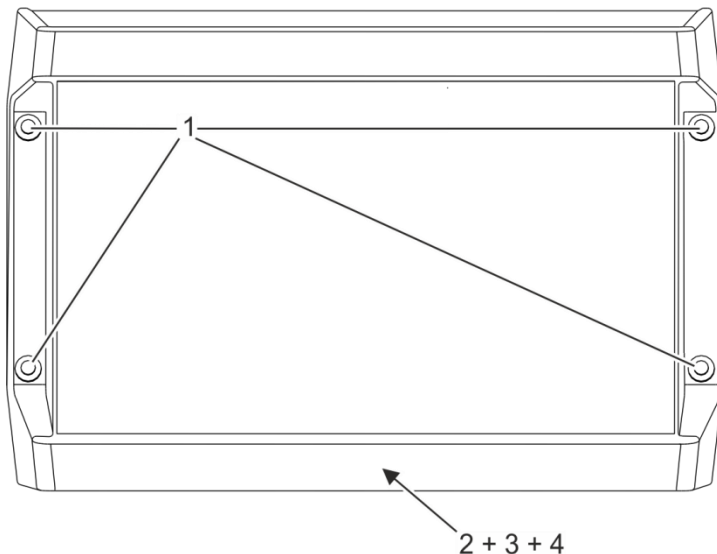

Fig. 185: Dismantling the pump controller

- | | |
|---|----------------------------|
| 1 | Holes for fastening screws |
| 2 | Slot A |
| 3 | Slot B |
| 4 | Slot C |
3. Disconnect all connections (slots A – C, Fig. 185/2, 3, 4).
 4. Safeguard the pump controller to prevent it falling.
 5. Undo the fastening screws (Fig. 185/1) and remove the pump controller.

Disposal

The national and local regulations regarding disposing of industrial waste must be observed when disposing of the pump controller and packaging material.

10 Licensing information

Licence conditions for the Software packages used

The pump controller's firmware contains open-source software. The licence conditions for the open-source software packages used are saved on the pump controller in the archive file `bplogic_licences.zip`. You can copy the archive file from the pump controller to a PC and unpack it there.

Use your web browser to open the "index.html" file that it contains in order to display an overview of the open-source software packages that are present and the corresponding licence conditions.

You can obtain the source code with the licence conditions for the open source software upon request from K.H. Brinkmann GmbH & Co. KG. Send your request by e-mail to support@brinkmannpumps.de and make the subject "bplogic Open-Source-Software".

11 EC Declaration of Conformity

DEUTSCH / ENGLISH / FRANÇAIS / ESPAÑOL



EG-Konformitätserklärung

EC declaration of conformity / Déclaration de conformité CE /
Declaración de conformidad CE

Hersteller / Manufacturer / Constructeur / Fabricante

Brinkmann Pumpen, K. H. Brinkmann GmbH & Co. KG
Friedrichstraße 2, D-58791 Werdohl

Produktbezeichnung / Product name / Désignation du produit / Designación del producto

Pumpensteuerung / Pump Control Unit / Commande de Pompe / Control de Bombeo

Typ / Type / Tipo **bplogic**

Das bezeichnete Produkt stimmt mit den folgenden Richtlinien des Rates zur Angleichung der Rechtsvorschriften der EG-Mitgliedsstaaten überein:

The named product conforms to the following Council Directives on approximation of laws of the EEC Member States:

Le produit sus-mentionné est conforme aux Directives du Conseil concernant le rapprochement des législations des Etats membres CEE:

El producto designado cumple con las Directivas del Consejo relativas a la aproximación de las legislaciones de los Estados Miembros de la CEE:

2014/30/EU Richtlinie für elektromagnetische Verträglichkeit
2014/30/EU Council Directive for Electromagnetic compatibility

2011/65/EU Richtlinie zur Beschränkung der Verwendung bestimmter gefährlicher Stoffe in Elektro- und Elektronikaltgeräten

2011/65/EU Directive on the restriction of the use of certain hazardous substances in electrical and electronic equipment

Die Übereinstimmung mit den Vorschriften dieser Richtlinien wird nachgewiesen durch die vollständige Einhaltung folgender Normen:
Conformity with the requirements of this Directives is testified by complete adherence to the following standards:

La conformité aux prescriptions de ces Directives est démontrée par la conformité intégrale avec les normes suivantes:

La conformidad con las prescripciones de estas directivas queda justificada por haber cumplido totalmente las siguientes normas:

Harmonisierte Europ. Normen / Harmonised Europ. Standards / Normes europ. harmonisées / Normas europ. Armonizadas

EMV CE-Störfestigkeit : DIN EN 61000-6-2:2007 + A1:2011

EMV CE-Störaussendung: DIN EN 61000-6-4:2005

RoHS : DIN EN IEC 63000:2019-05

Die Hinweise in der Betriebsanleitung für den Einbau und die Inbetriebnahme der Pumpensteuerung sind zu beachten.

The instructions contained in the operating manual for installation and start up the pump control unit have to be followed.

Les indications d'installation / montage et de mise en service du convertisseur de fréquence prévues dans l'instruction d'emploi doivent être suivies.

Tenga en cuenta las instrucciones en el manual para la instalación y puesta en marcha del regulador de accionamiento.

Brinkmann Pumpen, K. H. Brinkmann GmbH & Co. KG

Werdohl, 10.09.2019



Reimund Gidde
Geschäftsführer
Managing Director

Dr. H. Abou Dayé
K. H. Brinkmann GmbH & Co. KG
Friedrichstraße 2, D-58791 Werdohl
Dokumentationsbevollmächtigter /
Representative of documentation/
Mandataire de documentation /
Mandatario de documentación

12 Accessories and required materials

The following materials are required for the work described in this operating manual:

Service access cover

Cover made of die-cast aluminium; if using USB WLAN mode, made of plastic with seal and screws for proper sealing and to retain the housing protection category

Standard glasses cleaning cloth

Soaked in cleaning fluid

M12 sealing caps

To seal unused M12 connections

M12 sealing caps are supplied as standard.

Micro SD card

Standard micro SD memory card with a maximum capacity of 32 GB

Formatted as FAT16 or FAT32

USB storage medium or a micro SD card containing the current system backup

USB storage medium or a micro SD card containing the current software backup in accordance with the specifications in this section

USB storage medium or a micro SD card containing the current software

USB storage medium or a micro SD card containing the current software in accordance with the specifications in this section

USB storage medium

Standard memory stick, maximum protrusion of 1.5 mm when inserted

Formatted as FAT16 or FAT32

USB WLAN dongle

EDIMAX EW-7811Un dongles or comparable products with a Realtek

RTL8188CUS chip set. The dongle may only protrude by 1.5 cm when inserted.

Soft cloth

Dampened with water, to clean the housing

13 Index

- A**
- Access using web browser..... 54
 - Action
 - add..... 140
 - delete 140
 - Action block
 - add action 140
 - delete action..... 140
 - Actuators 41
 - maximum permissible current.. 50
 - parameter setting 179
 - power supply 36, 50
 - Additional functions..... 238
 - automatic time setting..... 245
 - logging 239
 - WLAN 243
 - Adjustment mode.....100, 105
 - Ambient conditions 271
 - Analog inputs/outputs41, 172, 274, 276
 - Anglo-American measurement system 194
 - Application 10, 91
 - overview..... 226
 - Application modules..... 25, 28
 - assigned pumps 228
 - checking parameters 92
 - defining favourites 97
 - manual mode 101
 - parameter setting 100
 - Application oscilloscope..... 231
 - channels..... 234
 - Application overview 226
 - Applications 25
 - checking parameters.....92
 - defining favourites.....97
 - Automatic mode 38, 99, 230
- B**
- Backup197, 249
 - Backup system249
 - Boost activation (saw tooth cycle mode).....111
 - Boot sequence28, 52
 - Browser access54
- C**
- Channel.....240
 - Clock272
 - COM 132
 - pin allocation50
 - Command (logic module).....117
 - Communication interfaces269
 - Comparison (logic function)126
 - Complete installation7
 - Configuration (menu overview)84
 - Connecting the machine controller via a PROFINET IO field bus214
 - Connection values272
 - Continuous operation237
 - Control line41
 - Control mode..... 103, 105
 - Control parameters..... 228
 - Customer service.....8
- D**
- Date/time
 - automatic setting.....245
 - set by hand195
 - Device restart200

Digital inputs/outputs 41, 169, 273, 275
Dimensions 268
Dismantling 279
Display area, left 62
Display area, right 62
Display elements 68
Display options 191
Displaying 164
Displays 58, 68
Disposal 280
Documents, further applicable 7
Download 218
Dropdown list 75

E

Earthing 46, 48, 50
Electronic components 24
Entering energy costs 194
Error message see Event message
Ethernet 32, 34, 41, 269
 parameter setting 201
 pin allocation ETH 1 49
EtherNet/IP field bus 211
Event ID (logic module) 131
Event list 262
Event message 259
 acknowledge 260
 close 260
 delete 263
 hide 263
 read 265
Event messages (logic module) 129

F

Fault table 266
Favourite
 define 97
 display 226
Field bus 41, 207, 269

File
 renaming, deletion, saving 199
File manager 81
File operations 199
Fixed target values 104
Flags (logic module) 131
Follow-up time 128
Frequency adjustment mode . 100, 105
Frequency converter ..25, 41, 188, 269
 adjustment mode 100, 105
 network topology 41
 parameter setting 179
 supports 11
 with I/O 180
Functional earth 48, 50
Functions 269
Further applicable documents 7

H

Horizontal swiping 71
Housing 27
 cleaning 247
 degree of contamination 268
 dimensions and weight 268
 overvoltage category 268
 protection category 30, 268
 protection class 268
Hydraulics 185

I

I/O connections 29, 41
I/O level 29
 slot A 30
 slot B 31
 slot C 32
I/O module 1 30
 pin allocation 46

technical data	273	Lock screen	223
I/O module 2	31	removal	224
pin allocation	47	Logging	239
technical data	275	channel	240
Icons		exporting data	243
in the manual	12	icon	58
IF-THEN-ELSE structure	120	on/off	68
Information	see Event message	switch-on	193
Initial commissioning	52	Logging in	52
Input fields	73	Logic function	120
Input helps	73	command variable	125
Installation	39	comparison variable	124
materials	284	condition	126
Instruction	22	ELSE value	124
Interfaces	269	IF value	123
IP address		IF-THEN-ELSE	121
ethernet	201	THEN value	124
WLAN	205	Logic module	117
K		activate	152
Keyboard	73	check	136
Konformitätserklärung	282	checking the set parameters ..	152
L		command	117
LAN	201	parameter setting	136
LAN 1	32	plan	120
connection	34	set action parameters	142
on/off	68	set marker parameters	138
parameter setting	202	Login	
LAN 2	34	password change	196
connection	34	Login screen	52
on/off	68	password change	196
parameter setting	202	M	
Language setting	191	M12 sealing caps	43
Lead time	127	Main menu overview	83
Lead time (logic module)	120	Main screen	62
Left display area	62	Maintenance	
Link (logic function)	127		

cleaning the pump controller ..247
 materials284
 pump controller247
 Manual mode 38, 99, 101, 230
 Markers
 parameter setting 138
 Markers (logic module) 120
 Materials284
 Micro SD card33
 ejection 199
 Misuse..... 14
 Modbus
 pin allocation COM 150.....50
 Modbus RTU 32, 35, 41, 207, 269
 Motor..... 187

N

Navigation70
 Navigation bar59
 application single view60
 main menus60
 pump single view60
 Navigation elements63
 Network topology
 connections41
 NTP server245

O

Offset 115, 157
 Offset control..... 157
 On-screen keyboard..... 73
 Operating conditions271
 Operating gestures 71
 Operating mode.....38
 Operating principles56
 Operating system28
 Operating temperature271
 Operation pause.....237
 Operational readiness38

 missing 38, 99
 Operational readiness missing .. 38, 99
 Operator (logic function) 126
 Overflow warning (saw tooth cycle mode) 111
 Owner 19

P

Packaging 24, 279
 Parallel mode 105
 Password change..... 196
 PELV50
 Physical units selection 194
 Pin allocation
 I/O module 1 46
 I/O module 2 47
 power module 49
 Point of contact 8
 Power module 32
 pin allocation 49
 Power supply 32
 actuators..... 36
 pin allocation PWR module 50
 pump controller 36
 sensors 36
 Pressure increase 115, 227
 Pressure preselection 157
 Primary functions 100
 Process size control 103
 PROFINET IO field bus 210
 activate 214
 checking the set parameters .. 213
 connect to machine controller 214
 parameter setting..... 211
 Proper use 14
 Protection category 30, 268
 Pump controller
 dismantling 279

- installation 39
 - power supply36, 272
 - storage 279
 - switch-off 237
 - technical data 268
 - transport 279
 - Pump overview 228
 - Pump single view
 - wear detection 161
 - Pumps 41
 - adjustment mode100, 105
 - assigned application modules 228
 - control mode103, 105
 - manual mode 230
 - parameter setting 182
 - pump group 105
 - saw tooth cycle mode 109
- Q**
- Qualifications 21
 - Quick access (dialogue) 68
- R**
- Reboot 267
 - Re-commissioning 237
 - Removable storage device
 - boot sequence 28, 52
 - ejection 224
 - setup 218
 - Removable storage device ejection 199
 - Reset factory settings 256
 - Reset to factory settings 256
 - Restart200, 267
 - Restorable parameters display 191
 - Restore197, 249
 - Restore system 249
 - Right display area 62
 - RJ45201
- S**
- Saw tooth cycle mode
 - function109
 - parameter setting111
 - Scope of supply278
 - Screen
 - brightness71
 - lock68, 223
 - unlock223
 - Screen layout56
 - Screen navigation63
 - Screen rotation191
 - Sealing caps30, 43
 - Secondary functions157
 - Selecting units194
 - SELV50
 - Sensors41
 - parameter setting178
 - power supply36, 50
 - Service8
 - Service access222
 - ethernet34, 201
 - opening/closing204
 - USB33
 - Setting I/O parameters167
 - SI units194
 - Sleep activation (saw tooth cycle mode)111
 - Slot A30
 - Slot B31
 - Slot C32
 - Software switch67
 - Source parameters (logic module) .119
 - Staff21
 - Status bar58
 - Storage279
 - Storage device ejection224
 - Storage expansion33

-
- Storage media 218
 - connect 221
 - Storage temperature 271
 - Swiping
 - horizontal 71
 - vertical 71
 - Switch off 237
 - Switching on 52
 - System events 259
 - System settings 189
- T**
- Target parameters (logic module) .. 119
 - Technical data 268
 - Time/date
 - automatic setting 245
 - set by hand 195
 - Timer (saw tooth cycle mode process)
 - boost activation 111
 - overflow warning 111
 - sleep activation 111
 - Title bar 59
 - Touchscreen 28
 - brightness 68
 - cleaning 247
 - keyboard 73
 - lock 68, 223
 - navigation 63
 - switch 67
 - technical data 268
 - unlock 223
 - Transport 279
 - Type plate 278
- U**
- Upload 218
- USB 269
 - storage device ejection 199
 - USB connection 33
 - USB storage medium 33
 - Use 14
 - User administration 196
 - User-defined event messages
 - determine event ID 129
 - User-defined event messages 129
 - User-defined event messages
 - create 132
 - Using buttons 70
 - Using lists 75
 - Using software switches 70
- V**
- Vertical swiping 71
- W**
- Warning message see Event message
 - Wear detection 158
 - overview 161
 - parameter setting 158
 - perform 163
 - show result 164
 - Wear measurement 158
 - Web address 54
 - Weight 268
 - WLAN 33
 - icon 58
 - on/off 68, 243
 - parameter setting 204
 - projected 205, 244
 - technical data 270
 - USB dongle 270
 - Writable parameters display 191
-

